



黃山石瓷磚

| 一 | 塊 | 改 | 變 |

2026

綠建材專刊

工程級綠建材 | 減碳 × 安全 × 耐用

工程級綠建材 | 黃山石瓷磚

黃山石瓷磚深耕台灣，洞察現代建築與 ESG 轉型趨勢。我們深知工程端的關鍵挑戰不僅在於材料選用，更在於符合法規、施工穩定性與全生命週期的資產維護成本。

黃山石瓷磚以「安全、耐用、永續」為核心，提供的不僅是陶瓷工藝，更是具備數據化、透明化的審查文件以及穩定供應鏈的工程解決方案。



工程選材，不只是材料選擇，
更是一項風險管理的決策。

企業理念與永續承諾

永續，不只是一項理念，而是工程端可驗證的實際能力

1 | 減碳科技材料

以石英磚工藝取代天然石材，降低環境負擔並提升工程耐用度。

- 環境效益 | 減少超過 80% 天然礦石使用量。
- 能源優化 | 優化燒成流程，降低 10-15% 能源消耗。
- 物理性能 | 瓷磚低吸水性、低損耗，壽命更長、維護成本更低。
- 綠色認證 | 再生含量符合綠建材標章認證，可作為 ESG / 標案加分之佐證文件。

2 | 3R 循環永續策略

從製程到產品生命週期的全面落實。

- Reduce 減量 | 降低瓷磚吸水率與破損率，減少建案施工浪費與維修成本。
- Reuse 再利用 | 生產落料與瑕疵品可重新投入配方，提高原料使用效率。
- Recycle 回收再製 | 部分產品導入回收料，並可應客戶需求提供後端回收建議。

3 | 工程級品質與供應鏈

專注石英磚研發，建立完整的品質控管系統。

- AI 智能檢測 | 嚴格把關尺寸精準度與平整度。
- 台灣在地生產 | 降低供應鏈斷鍊風險，縮短物流碳足跡。
- 國家標準 | 全系列產品皆符合 CNS 國家標準與綠建材規範。

產品優勢與全方位解決方案

針對建案常見風險，提供完整對應解決方案。

1 | 法規與審查風險

通過國家級綠建材標章、防滑測試與 CNS 國家標準，可直接納入送審與工程文件，降低補件、退件與審查延誤風險。

2 | 安全與責任風險

防滑係數通過國家檢測標準 (CNS 3299-12)：

- 室內空間：C.S.R \geq 0.55
- 戶外與高風險區域：C.S.R \geq 0.75 (適用於浴室、高齡宅、公共動線、戶外空間)

3 | 施工與交期風險

台灣在地生產與穩定庫存配置，搭配完整生產與出貨調度，協助專案準時完工，降低交期不確定性。

4 | 後續維修與長期成本風險

五級抗污、低吸水率、耐磨耐候性能，減少後續清潔、維修與更換頻率，有效降低全生命週期成本。

工程應用快速選材導引

本表可作為工程規劃、設計討論與初步選材之快速參考。

實際產品選用建議依使用場域、人流密度與安全等級，由工程顧問或建築師進行最終規劃確認。

使用場域	建議規格 (cm)	防滑需求	推薦產品方向
室內公共空間	60×60 / 120×60	C.S.R \geq 0.55	防滑磚、雙塗層系列
浴室 / 更衣室	30×30 / 60×30	C.S.R \geq 0.55	高防滑、防污系列
樓梯 / 梯廳	樓梯磚一體成型	C.S.R \geq 0.55	防滑樓梯磚、倒圓梯磚
戶外步道 / 中庭	120×60 / 60×60	C.S.R \geq 0.75	厚片石板磚2.0
坡道 / 出入口	60×30	C.S.R \geq 0.75	厚片石板磚2.0

品質規範

所有性能皆符合 CNS 國家標準，可作為建案材料送審資料與工程規範依據。

項目	說明	CNS規範	黃山石標準
 吸水率	瓷磚磚體密度越大，孔隙就越少，吸水率因此降低。	3%以下	3%以下
 彎曲破壞載重	彎曲破壞載重越高，耐用度越高。	內裝壁： 108N以上 內裝地： 540N以上	內裝壁： 1000N以上 內裝地： 1800N以上
		外裝壁： 720N以上 外裝地： 1080N以上	外裝壁： 1000N以上 外裝地： 1800N以上
 厚度許可差	厚度許可差越小，鋪貼成果越平整、越美觀、安全。	$\pm 1.2\text{mm}$	$\pm 0.5\text{mm}$
 長度許可差	1.修邊磚：瓷磚燒成後會將四邊磨成設定的尺寸，長度及寬度的許可差較小。 2.不修邊磚：瓷磚燒成後會直接包裝使用，長度及寬度的許可差會較修邊磚大。 ※黃山石瓷磚的全產品皆使用紅外線尺寸機嚴格管控。	$\pm 2.4\text{mm}$	修邊磚： $\pm 0.6\text{mm}$
 寬度許可差		$\pm 1.6\text{mm}$	不修邊磚： $\pm 1.4\text{mm}$
 翹曲測試	在窯燒的過程瓷磚會因高溫造成邊角翹起，翹曲越大施工的難度越高，且交接處會凸起，易造成危險。	$\pm 1.2\text{mm}$	$\pm 0.8\text{mm}$
 耐藥品性	即耐酸鹼性。測試酸鹼性的清潔劑是否會破壞瓷磚表面。	A級	A級
 耐磨耗測試	即瓷磚表面的耐用程度。	0~5級	3級以上
 耐污染性	共5級，越高等級越容易清潔。	0~5級	5級



環保



節能



減碳



永續發展



產品圖示說明



雙塗層
創造亮紋視覺立體感
質感大提升。



防滑
國家標準防滑性測試
C.S.R 達0.55以上。



超輕薄
專為壁磚設計
輕薄又環保。



精雕雙塗層
絲綢觸感與立體凹凸亮紋
美感更升級。



防滑
國家標準防滑性測試
C.S.R 達0.75以上。



超厚實
磚體耐重，強度大幅提升
克服戶外多變的氣候變化。



耐久設計
磚體與磚面顏色相近
嚴重磨耗也不會影響美觀。



釉拋
磚面光滑潔亮，使空間散發
典雅優美的氛圍。



抓力提升
專為外牆磚設計，抓力更
提升。

編號特性說明

平面	F	數位雙塗層	D
模花	R	精雕雙塗層	E
啞光	M	防滑設計	A
釉拋	P	樓梯磚	T

色調紋理變化說明



V1 色調和紋理變化低
表面色感單一



V2 色調和紋理變化柔和
效果自然流暢



V3 色調和紋理變化豐富
增添層次感



V4 色調和紋理變化強烈
視覺效果顯著



Index

size(mm) color

120x60
P.01



61701FD 61704FD 61190RA 61116FA 61195RA 61191RA 61192RA 61196RA 61193RA 61706FE

61194RA 61110FA 61702FD 61712FD 61198RA 61197RA 61199RA

This block displays 17 color swatches for the 120x60 P.01 size. The swatches are arranged in two rows. The first row contains 10 swatches with codes: 61701FD, 61704FD, 61190RA, 61116FA, 61195RA, 61191RA, 61192RA, 61196RA, 61193RA, and 61706FE. The second row contains 7 swatches with codes: 61194RA, 61110FA, 61702FD, 61712FD, 61198RA, 61197RA, and 61199RA.

120x48
P.15



42501FD 42510TA 42516TA

This block displays 3 color swatches for the 120x48 P.15 size. The swatches are arranged in a single row with codes: 42501FD, 42510TA, and 42516TA.

105x48
P.17



48501TA 48510TA 48516TA

This block displays 3 color swatches for the 105x48 P.17 size. The swatches are arranged in a single row with codes: 48501TA, 48510TA, and 48516TA.

80x80
P.21



88701FD

This block displays 1 color swatch for the 80x80 P.21 size. The swatch is arranged in a single row with code: 88701FD.

60x60
P.22



66740FA 66701FDA 66700FDA 66130RA 66705FDA 66131RA 66190RA 66744FA 66195RA 66706FDA

66191RA 66194RA 66135RA 66192RA 66139RA 66193RA 66196RA 66739F 66709FDA

66702FDA 66743FA 66742FA 66198RA 66197RA 66199RA

This block displays 30 color swatches for the 60x60 P.22 size, arranged in three rows. The first row has 10 swatches (66740FA to 66706FDA). The second row has 9 swatches (66191RA to 66709FDA). The third row has 6 swatches (66702FDA to 66199RA).

105x18.5
P.43



10972R

This block displays 1 color swatch for the 105x18.5 P.43 size. The swatch is arranged in a single row with code: 10972R.

90x15
P.45



95970RA 95992FD 95974R 95973RA 95978RA

This block displays 5 color swatches for the 90x15 P.45 size. The swatches are arranged in a single row with codes: 95970RA, 95992FD, 95974R, 95973RA, and 95978RA.

size(mm) color

70x15
P.47

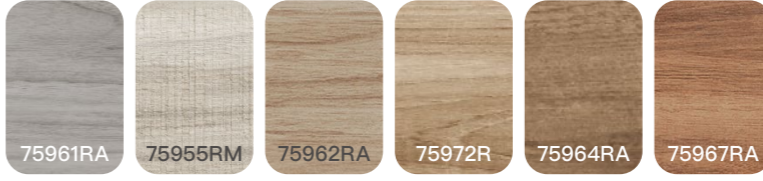

75961RA 75955RM 75962RA 75972R 75964RA 75967RA

This block displays 6 color swatches for the 70x15 P.47 size. The swatches are arranged in a single row with codes: 75961RA, 75955RM, 75962RA, 75972R, 75964RA, and 75967RA.

45x15
P.51



45960RA 45962RA 45963RA 45964RA 45967RA 45961RA 45937R 45939R

This block displays 8 color swatches for the 45x15 P.51 size. The swatches are arranged in a single row with codes: 45960RA, 45962RA, 45963RA, 45964RA, 45967RA, 45961RA, 45937R, and 45939R.

90x30
P.59



39760FE 39725R 39739F

This block displays 3 color swatches for the 90x30 P.59 size. The swatches are arranged in a single row with codes: 39760FE, 39725R, and 39739F.

60x30
P.61



36144FA 36170FP 36140F 36174FP 36741FA 36175FP 36701FDA 36141F 36740FA 36147FM

36171FP 36130RA 36700FDA 36155RA 36705FDA 36173FP 36744FA 36745FA 36131RA 36190RA

36195RA 36145FM 36121RA 36706FDA 36191RA 36135RA 36194RA 36156RA 36192RA 36146FM

36125RA 36193RA 36139RA 36119RA 36196RA 36709FDA 36129RA 36198RA 36197RA 36199RA

36142F 36702FDA 36172FP 36743FA 36742FA 36114RA 36117RA 36115RA

This block displays 50 color swatches for the 60x30 P.61 size, arranged in five rows. The first row has 10 swatches, the second and third rows have 10 swatches each, the fourth row has 10 swatches, and the fifth row has 10 swatches.

30x30
P.101



30347RA 30345RA 30331RA 30925RA 30335RA 30346RA 30339RA 30919RA 30915RA 30914RA

30917RA

This block displays 11 color swatches for the 30x30 P.101 size. The first row contains 10 swatches with codes: 30347RA, 30345RA, 30331RA, 30925RA, 30335RA, 30346RA, 30339RA, 30919RA, 30915RA, and 30914RA. The second row contains 1 swatch with code: 30917RA.

120x60 cm 模花/防滑/2cm厚磚/修邊



網頁介紹

120x60 cm 模花/防滑/2cm厚磚/修邊



網頁介紹

61190RA 厚片石板磚2.0

6種紋路



61192RA 厚片石板磚2.0

6種紋路



61191RA 厚片石板磚2.0

6種紋路

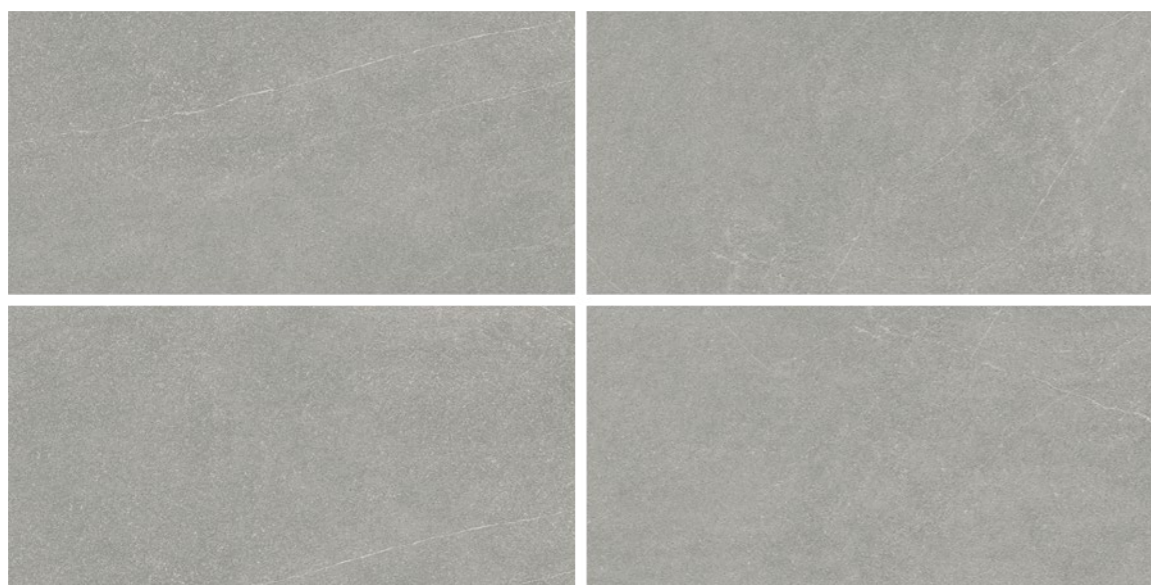

★為特別色等級



120x60 cm 模花/防滑/2cm厚磚/修邊



防滑



超厚實



紋理變化
柔和



網頁介紹

120x60 cm 模花/防滑/2cm厚磚/修邊



防滑



超厚實



紋理變化
柔和



網頁介紹

★61193RA 厚片石板磚2.0

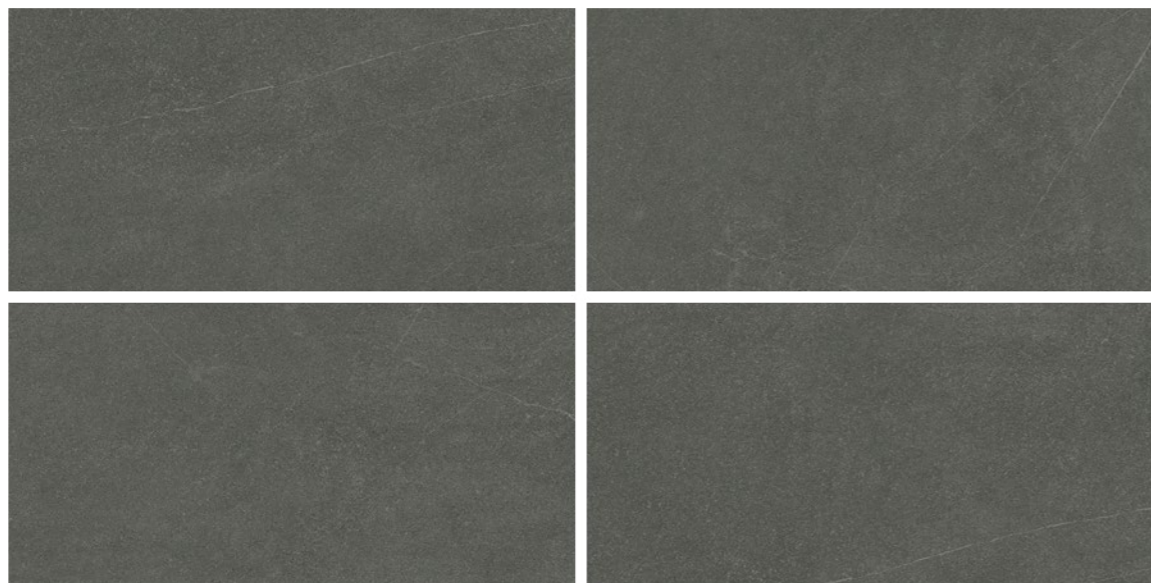

★61195RA 厚片石板磚2.0

6種紋路



★61194RA 厚片石板磚2.0

客訂
6種紋路



★61196RA 厚片石板磚2.0

6種紋路

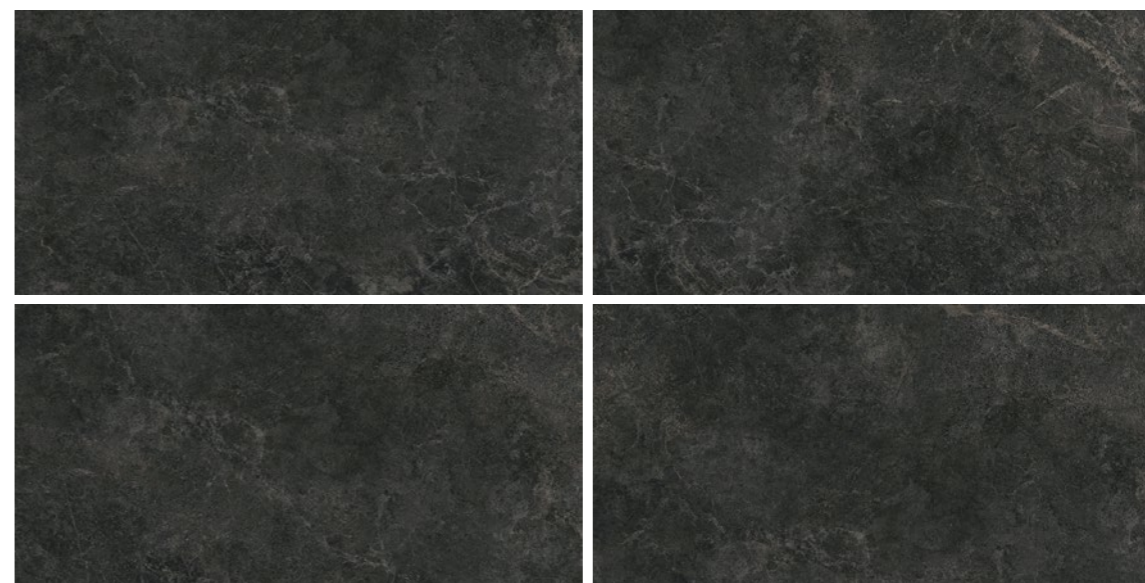

客訂品基本訂貨量:1000m²，具體訂購需求歡迎洽詢

★為特別色等級

120x60 cm 模花/防滑/2cm厚磚/修邊



防滑



超厚實



紋理變化
柔和



網頁介紹

120x60 cm 模花/防滑/2cm厚磚/修邊



防滑



超厚實



紋理變化
柔和



網頁介紹

★61102RA 原木厚磚

6種紋路



★61100RA 原木厚磚

6種紋路



★61197RA 原木厚磚

6種紋路



★61109RA 原木厚磚

6種紋路

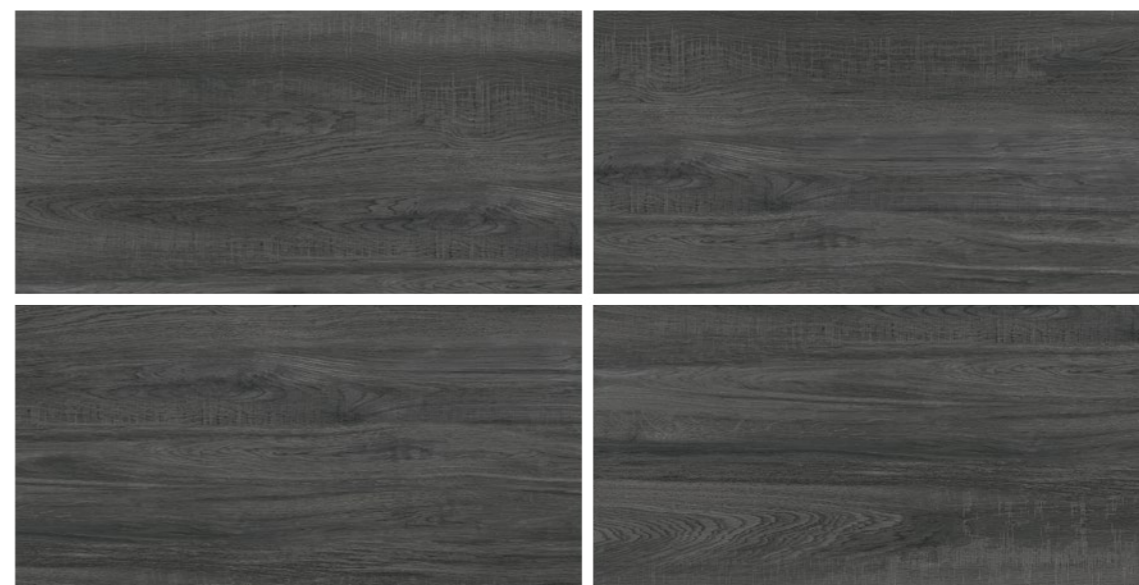

★為特別色等級

120x60 cm 模花/防滑/2cm厚磚/修邊



網頁介紹

★61198RA

原木厚磚

6種紋路



★61199RA

原木厚磚

6種紋路



★為特別色等級

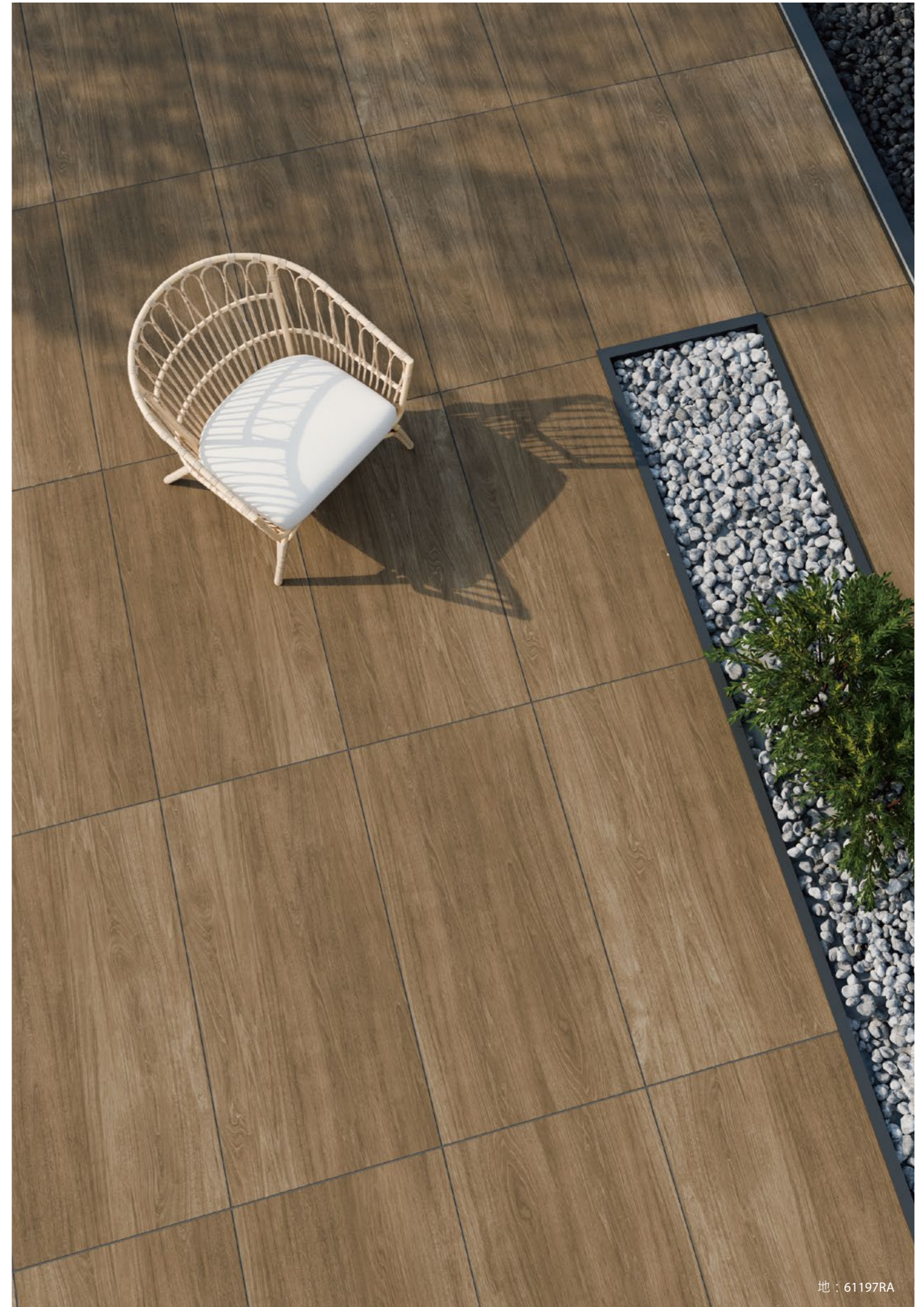

地：61197RA

工程級20mm 厚片石紋磚 I

厚片石板磚專為極端耐重需求與高強度工程設計。

以 20mm 的極致厚度，突破石材物理限制，挑戰天然石材，並通過綠建材認證，是現代低碳建築屋頂、戶外廣場與公共工程的首選材料。



三大核心優勢 | 安全·耐用·永續

1 防滑與清潔的完美平衡

防滑等級：C.S.R ≥ 0.75 (優於 CNS 3299-12 室外高風險標準)

抗污等級：國家五級抗污，油污、髒汙不易滲入

工程價值：降低公共空間滑倒事故與後續清潔維護成本

適用場域：浴室、陽台、戶外平台、高齡住宅、公共動線

2 超越天然石材的物理性能

彎曲破壞載重：>10,000 N

結構優勢：高耐重、抗裂、不易碎裂

低吸水率：避免天然石材常見的返鹼、潮濕、發黴問題

工程結論：適合高人流與長年戶外使用的穩定建材

3 綠色永續，為節能建築加分

雙認證：綠建材標章 × 環保標章

低碳優勢：再生原料製程，降低碳足跡

節能效益：架高系統形成空氣層，有效降低熱傳導

工程價值：可直接納入 ESG/綠建築評分項目

厚磚 vs. 天然石材：為什麼選擇厚磚？

	厚片石板磚	一般石材
耐久性	高溫燒製，堅固耐磨，不易碎裂	石材結構不均，加工過程風險較高
彎曲破壞載重	超過10000N以上	4800N以下
抗污性	五級抗污，好清潔	易吃色與卡髒汙
防滑性	C.S.R達0.75以上	石材濕水較滑，須額外加工處理
環保永續性	再生綠建材標章認證	需開採天然礦石，對環境影響較大

三種施工工法剖面

A 架高系統

快速排水，免破壞結構。
易維修，可重複拆裝。
降低長期結構滲水風險。

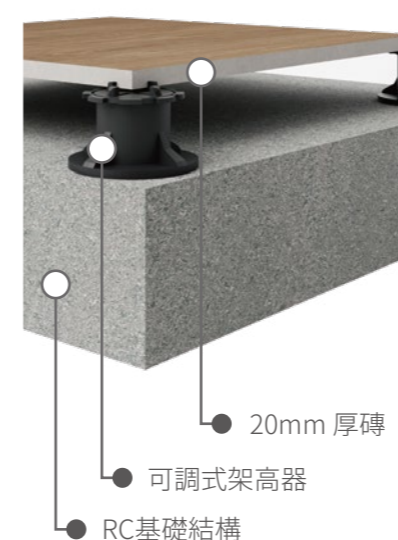

B 乾掛系統

高穩定度，適用大型公共工程。
易更換單片，降低後續維修成本。
外觀一致，施工品質可控。

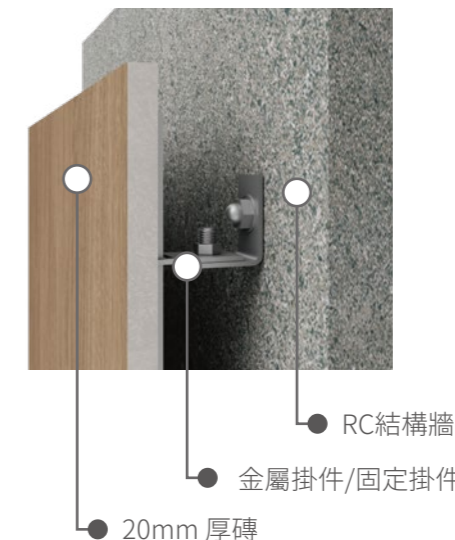

C 水泥砂漿鋪設

工法成熟，施工熟悉度高。
適合大面積地坪。
需搭配防水與排水設計。

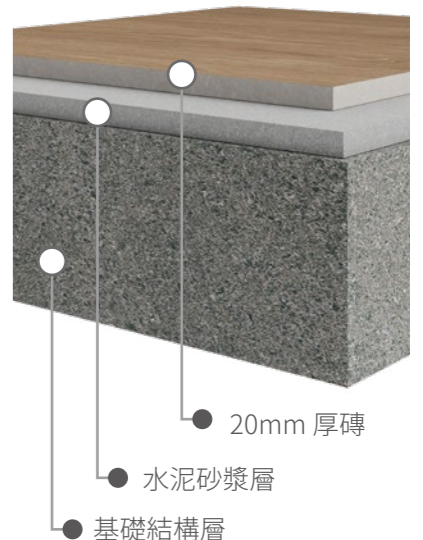

黃山石工程級厚磚 | 支援多種施工工法 | 全面降低工程風險



61110FA

大砌

6種紋路



可搭配48510TA、42410TA樓梯磚

61701FD

大砌

6種紋路



可搭配48501TD、42501TD樓梯磚

61116FA

大砌

6種紋路

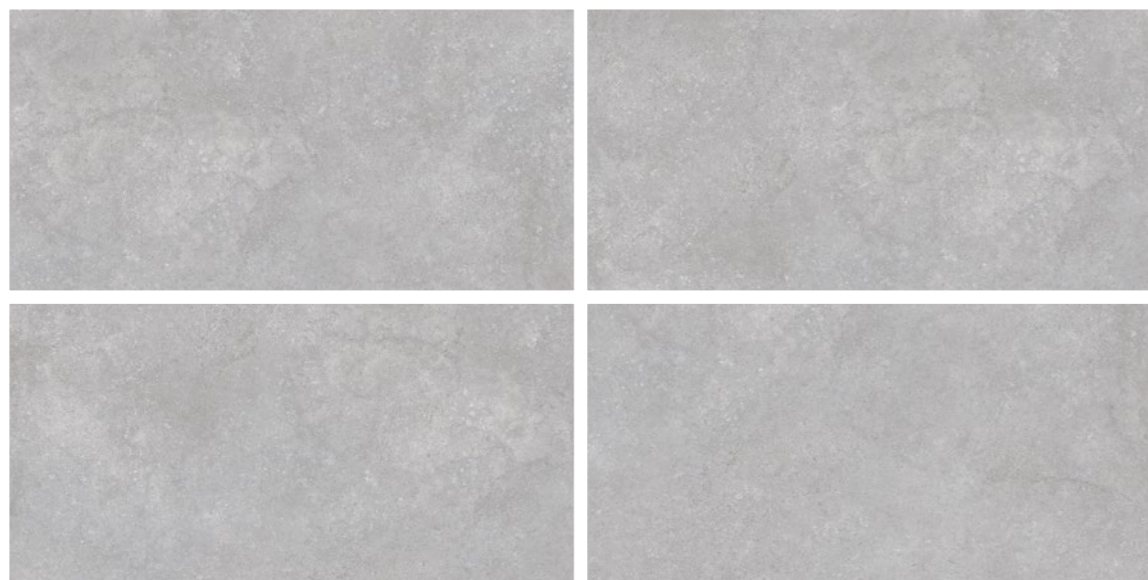

可搭配48516TA、42416TA樓梯磚

61702FD

大砌

6種紋路





雙圖層



V2
紋理變化
柔和



網頁介紹

61704FD

大砌

6種紋路



精雕雙圖層



V2
紋理變化
柔和



網頁介紹

61706FE

大砌

6種紋路

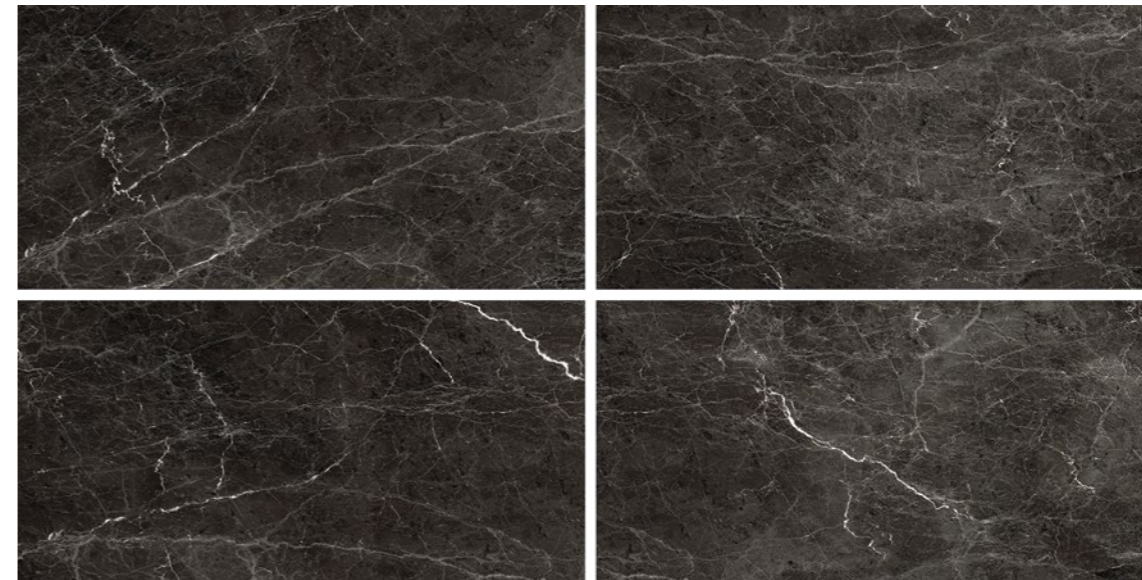

61712FD

大砌

6種紋路



地：61706FE



地：61110FA



地：61712FD



壁&地：61704FD



42510TA

大砌

6種紋路



可搭配61110FA

42501TD

大砌

6種紋路

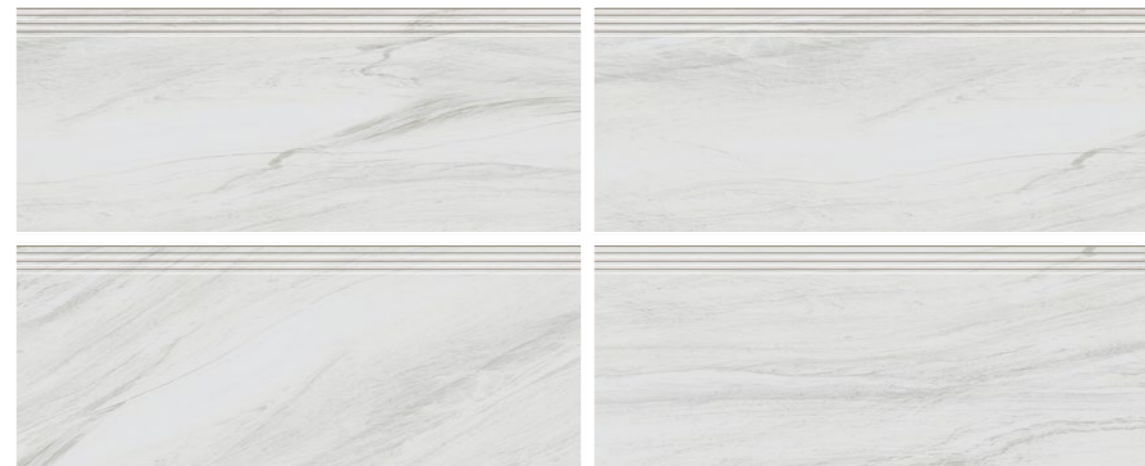

可搭配61701FD

42516TA

大砌

6種紋路



可搭配61116FA



梯：42501TD
地：61701FD



防滑



紋理變化
柔和



網頁介紹



雙圖層



紋理變化
柔和



網頁介紹

48510TA

大砌

6種紋路



防滑與溝槽視覺辨識，符合無障礙設計規範
可搭配61110FA

48501TD

大砌

6種紋路

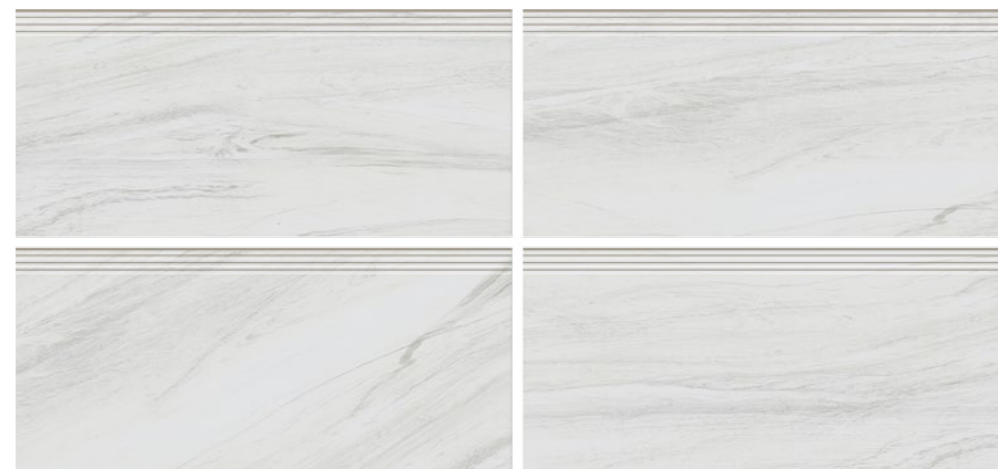

可搭配61701FD

48516TA

大砌

6種紋路

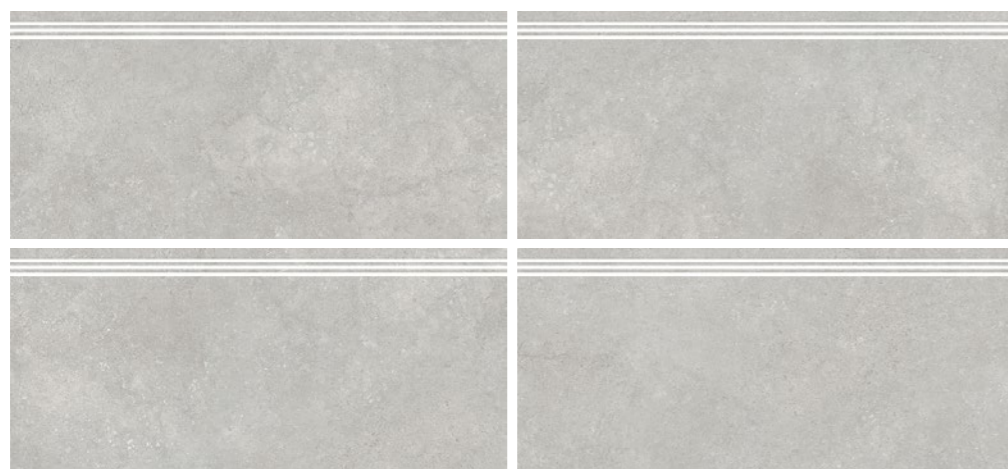

防滑與溝槽視覺辨識，符合無障礙設計規範
可搭配61110FA



梯：48516TA

一體化樓梯套磚系統

結合安全規範、施工效率與設計一致性的階梯設計。

A 安全設計

一體成型防滑溝槽 |

溝槽內部皆經過施釉工法，易清潔、不滲污並提升行走時的抓地力與安全性。

倒圓防踢腳設計 |

圓弧導角有效降低踢撞風險，提升日常行走安全性。

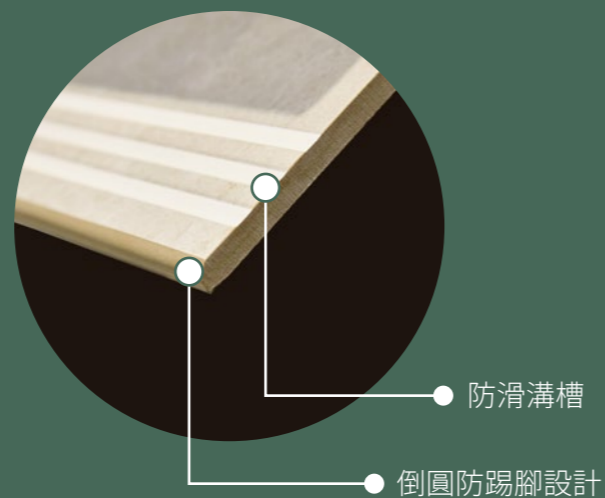

B 美觀與多元規格

多樣規格 |

樓梯磚提供 120 x 48cm 與 105 x 48cm 兩種尺寸，滿足不同梯間寬度需求。

空間一致性 |

另有 120 x 60cm、80 x 80cm 與 60 x 60cm 等規格，與室內地板整合，打造美觀視覺風格。

C 環保與高效施工

一片到頂無縫鋪貼 |

48 cm 的深度約等於一階(踏面加立面)的總長，減少拼接縫隙，視覺更完整、結構更穩定。

降低損耗 |

針對樓梯尺度量身打造的規格，能大幅減少現場裁切所產生的瓷磚損料，符合環保效益。



樓梯磚裁切示意圖(踏面+立面)

樓梯轉台裁切指南

※ 本示意圖以 100cm 梯寬為例，轉台以 120x60cm 裁切。

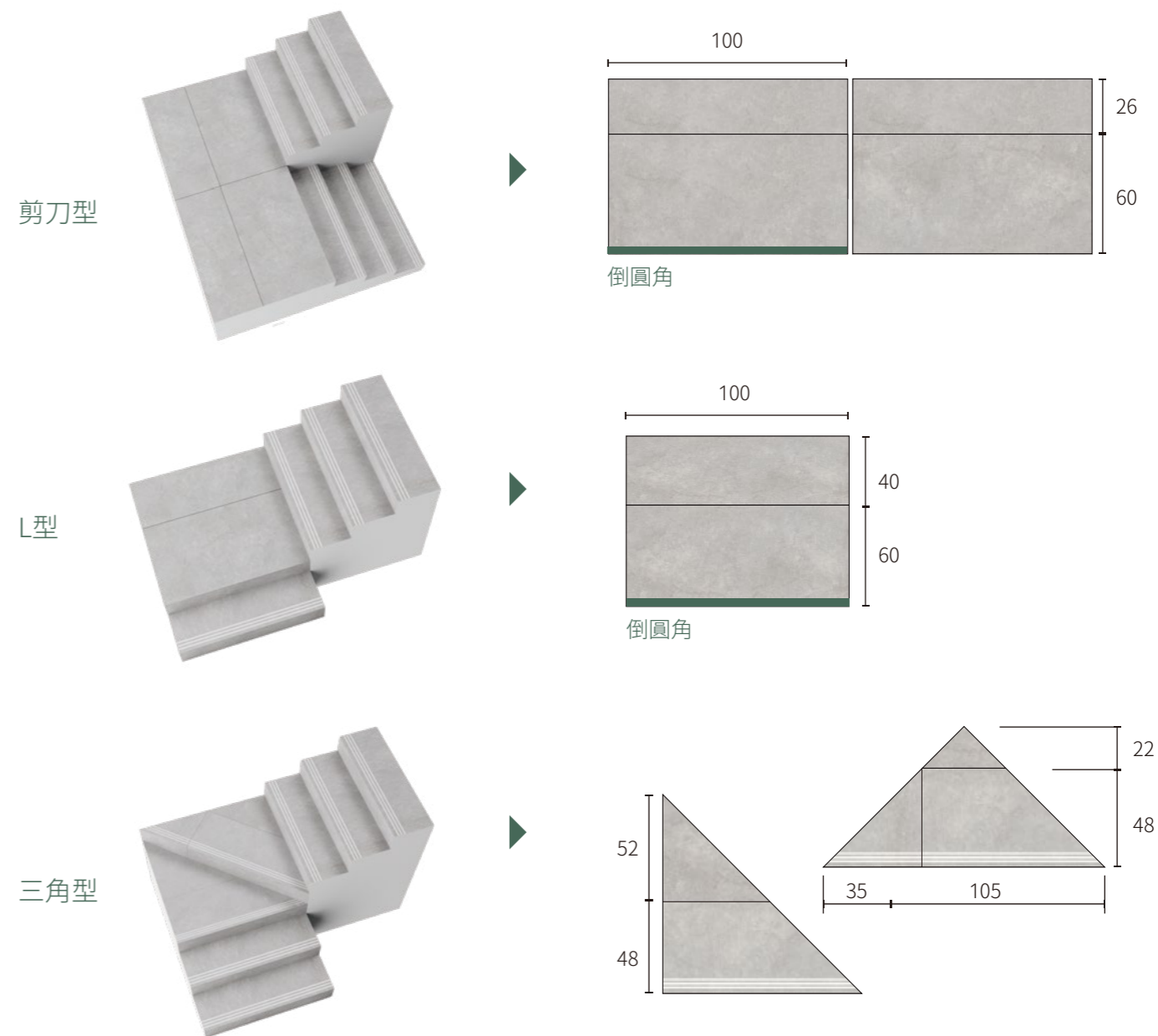

樓梯選材全指南

一體化樓梯套磚 vs. 天然石材全解析

	黃山石樓梯磚	一般石材
清潔與維護	高抗污、不滲色	易吃色、需打蠟
耐磨度	高抗折、耐酸鹼	質地軟、易磨損
施工效率	規格化、效率高	需裁切、工期長
整體美觀	色澤視覺穩定、一致	色差風險高
綜合成本	免後續保養	養護成本高

80x80 cm 平面/數位雙塗層/修邊



雙圖層

V2

紋理變化
柔和



網頁介紹

88701FD

大砌

6種紋路



60x60 cm 平面/修邊

V2

紋理變化
柔和



網頁介紹

66739F

雲煙石

10種紋路



地：88701FD



地：66739F



網頁介紹



網頁介紹

66190RA 厚片石板磚2.0

10種紋路



66192RA 厚片石板磚2.0

10種紋路



66191RA 厚片石板磚2.0

10種紋路



★66193RA 厚片石板磚2.0

10種紋路



★為特別色等級

60x60 cm 模花/防滑/2cm厚磚/修邊



網頁介紹

60x60 cm 模花/防滑/2cm厚磚/修邊



網頁介紹

★66194RA 厚片石板磚2.0

客訂
10種紋路



客訂品基本訂貨量:1000m²，具體訂購需求歡迎洽詢

★66196RA 厚片石板磚2.0

10種紋路

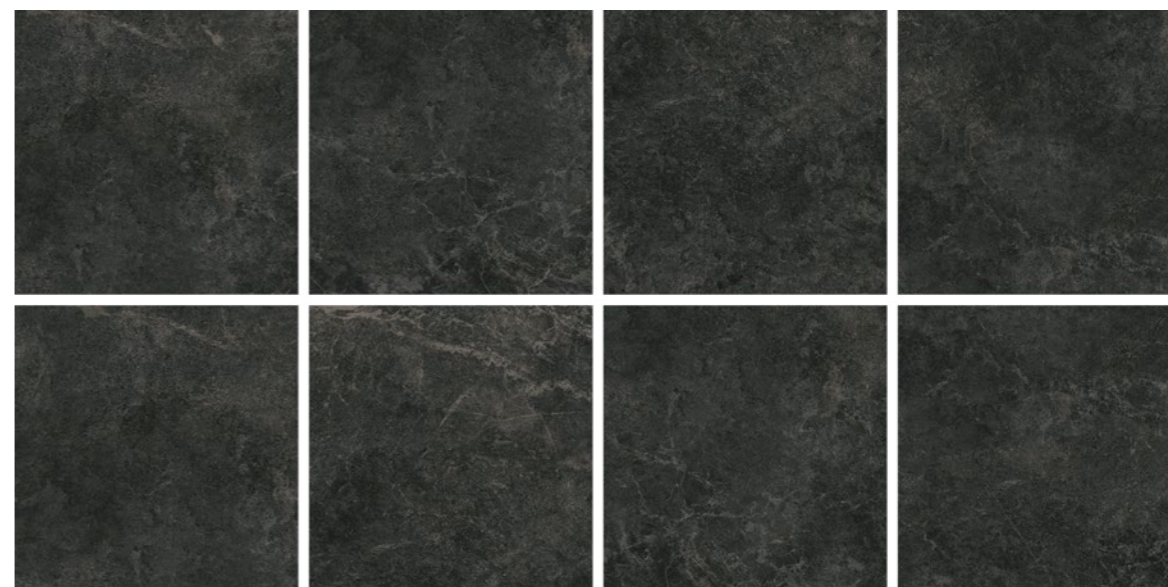

★66195RA 厚片石板磚2.0

10種紋路



★為特別色等級



地：66196RA

120x60 cm 模花/防滑/2cm厚磚/修邊



網頁介紹

120x60 cm 模花/防滑/2cm厚磚/修邊



網頁介紹

★66102RA 原木厚磚

10種紋路



★66100RA 原木厚磚

10種紋路



★66197RA 原木厚磚

10種紋路



★66109RA 原木厚磚

10種紋路

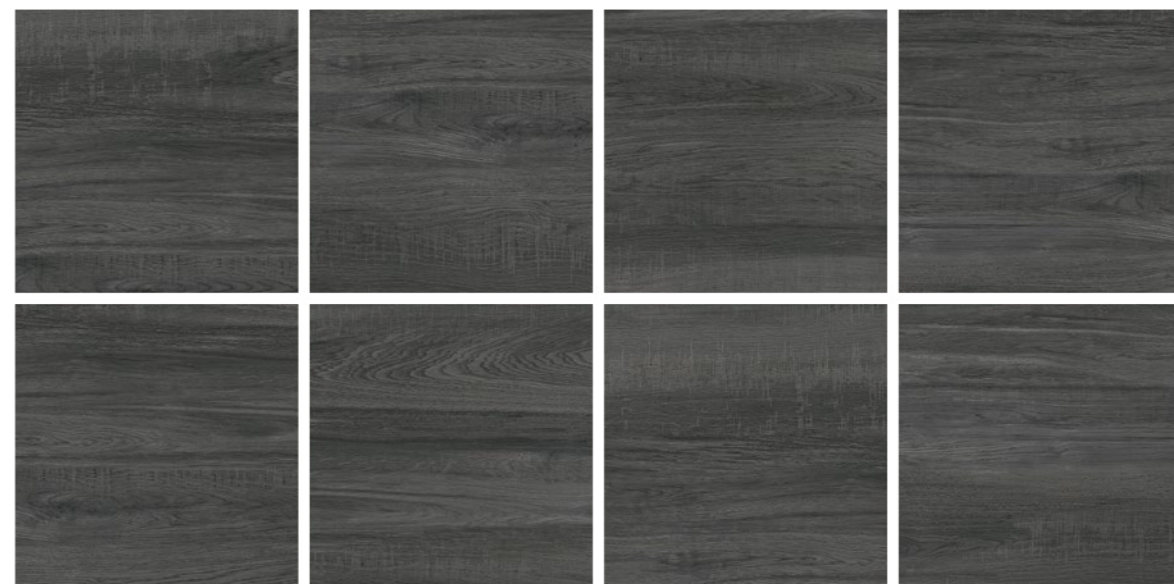

★為特別色等級

120x60 cm 模花/防滑/2cm厚磚/修邊

C.S.R
≥0.75
防滑

20mm
超厚實

V2
紋理變化
柔和



網頁介紹

★66198RA

原木厚磚

10種紋路



★66199RA

原木厚磚

10種紋路



★為特別色等級



地：66199RA



網頁介紹



網頁介紹

66700FDA

雅境

10種紋路



66702FDA

雅境

10種紋路



66701FDA

雅境

10種紋路



66705FDA

雅境

10種紋路



60x60 cm 平面/數位雙塗層/防滑/修邊



防滑



雙圖層



紋理變化
柔和



網頁介紹

★66706FDA

雅境

10種紋路

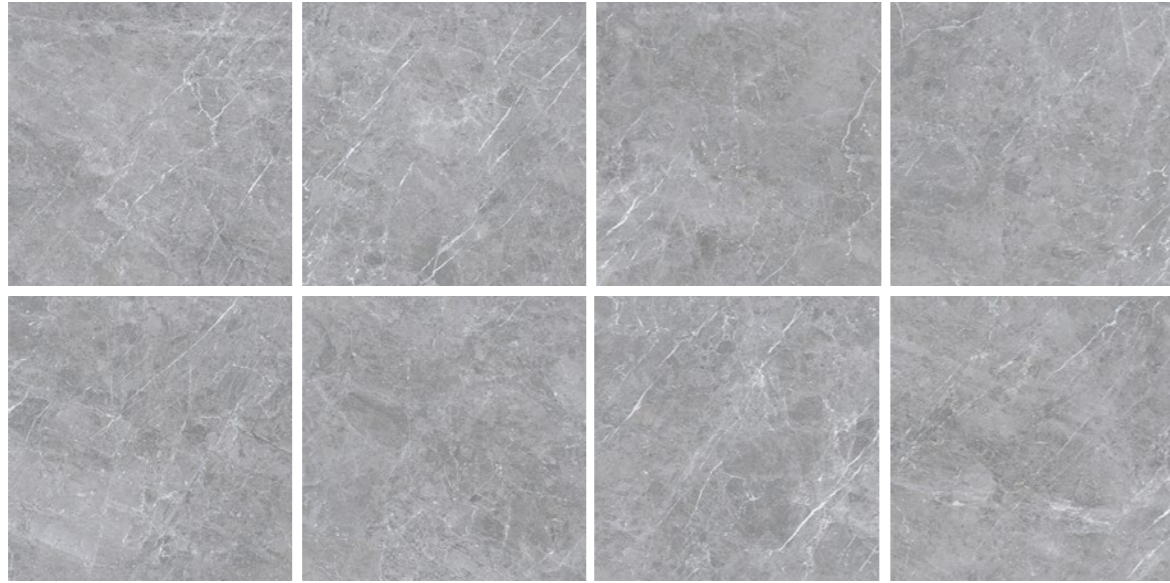

★66709FDA

雅境

10種紋路

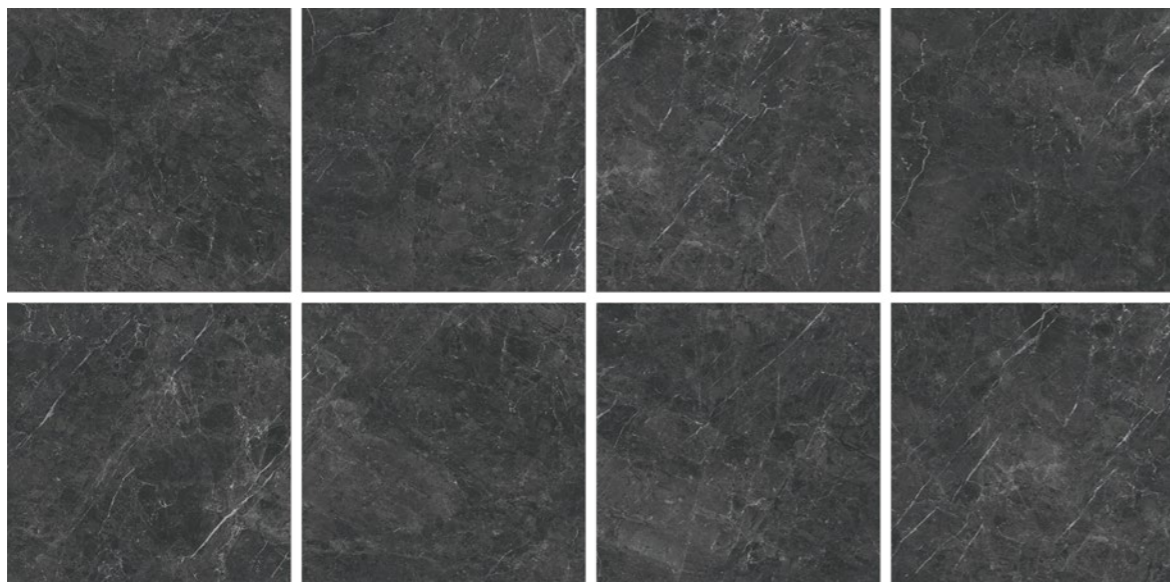

地：66706FDA





66130RA

龍岩2.0

9種紋路

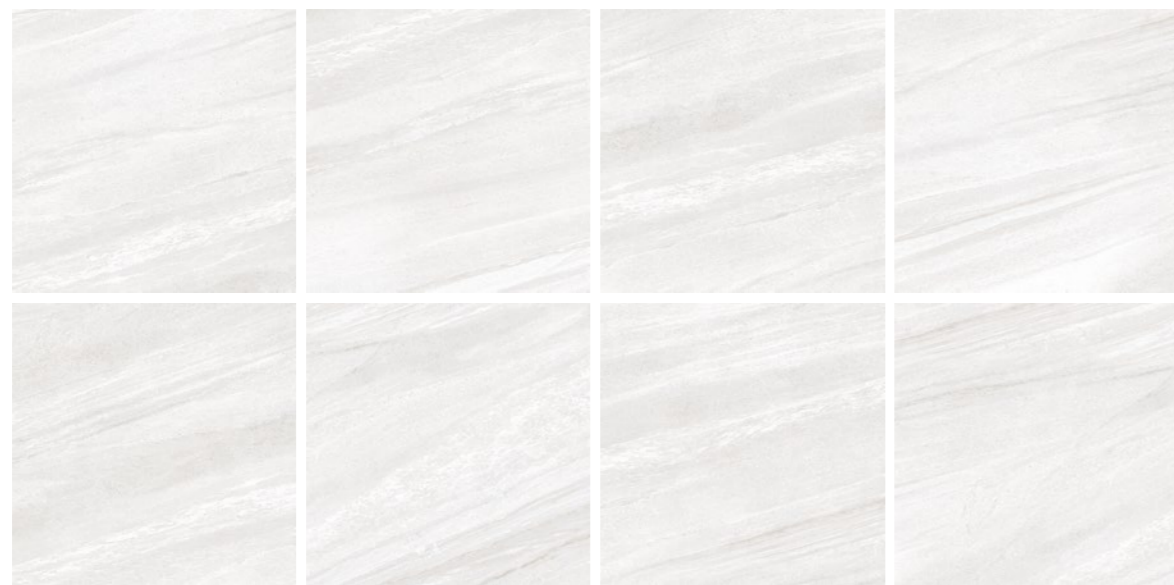

66135RA

龍岩2.0

9種紋路



66131RA

龍岩2.0

9種紋路



66139RA

龍岩2.0

9種紋路



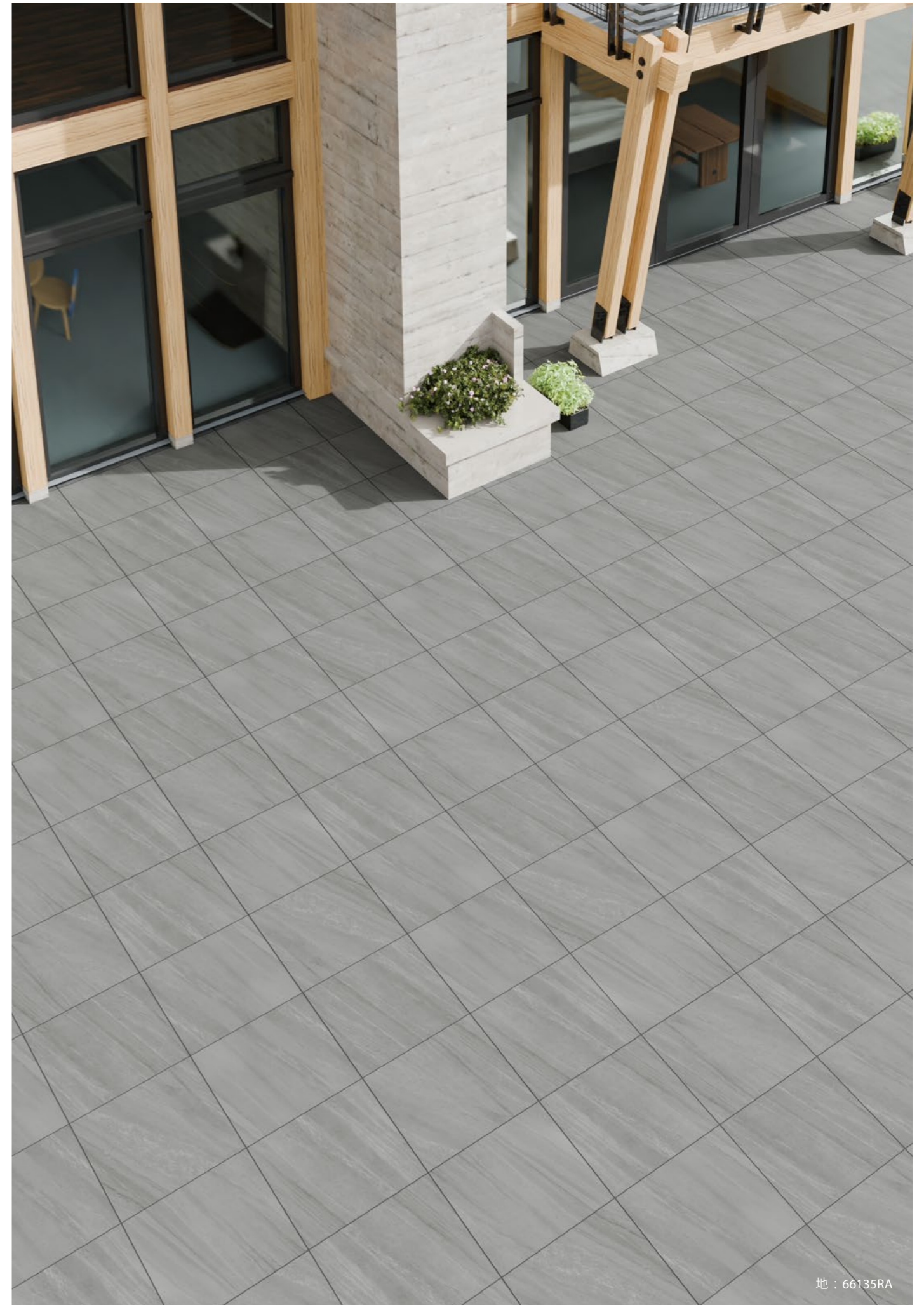

地：66135RA



網頁介紹



網頁介紹

66740FA

澄石

9種紋路

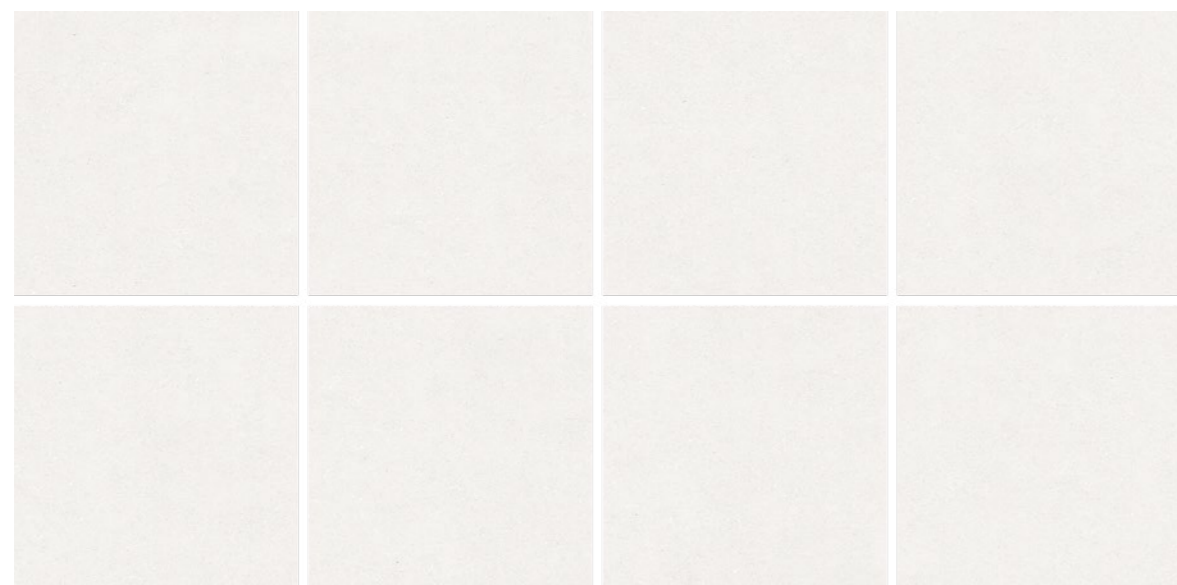

66743FA

澄石

9種紋路

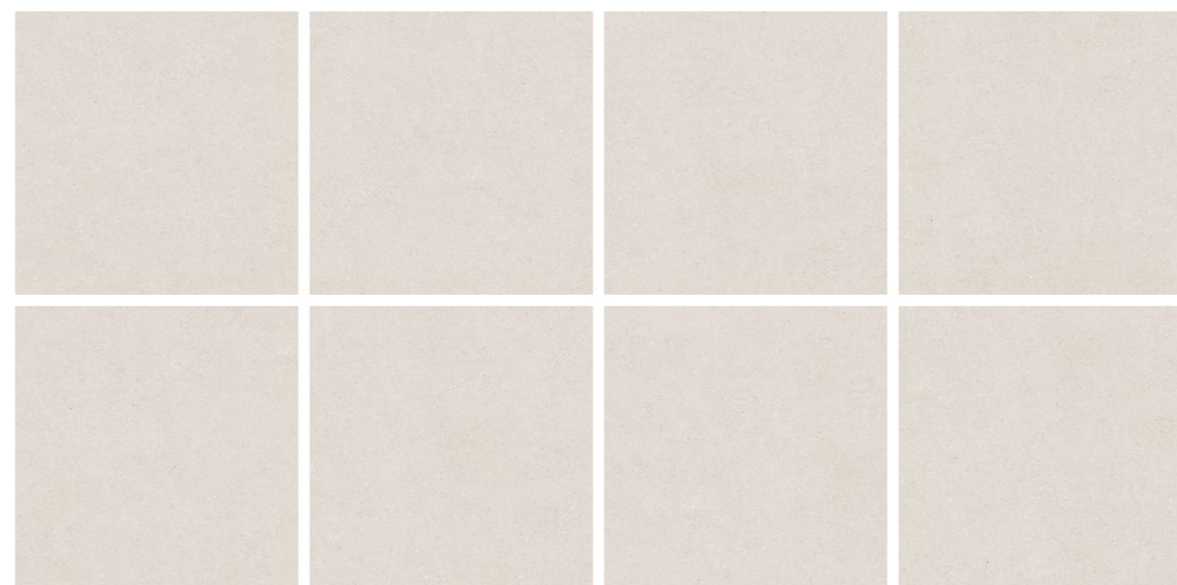

66742FA

澄石

9種紋路

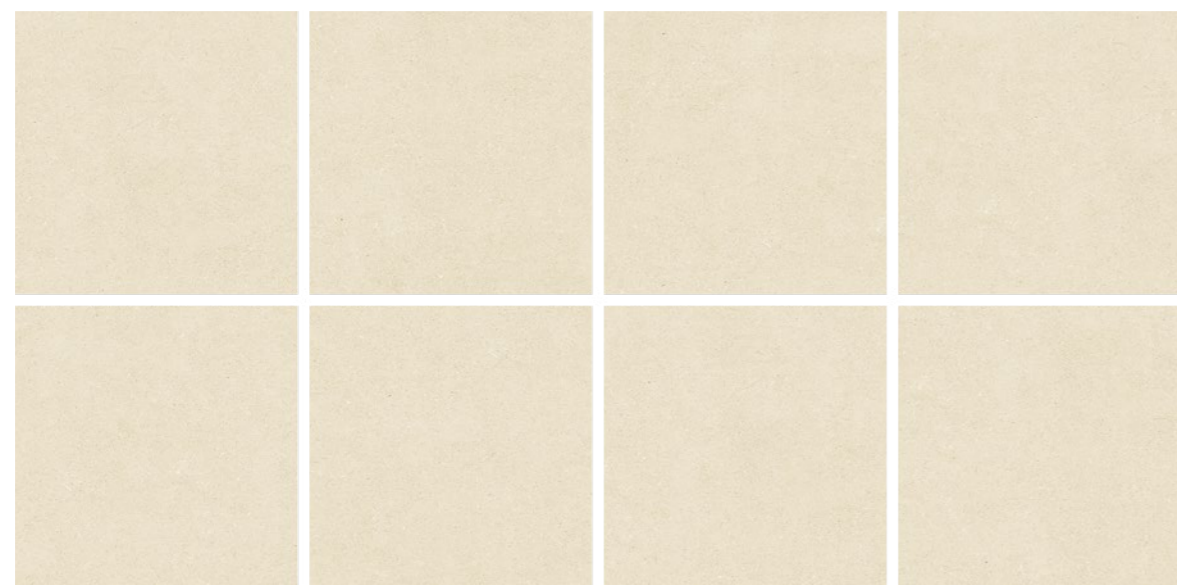

66744FA

澄石

9種紋路

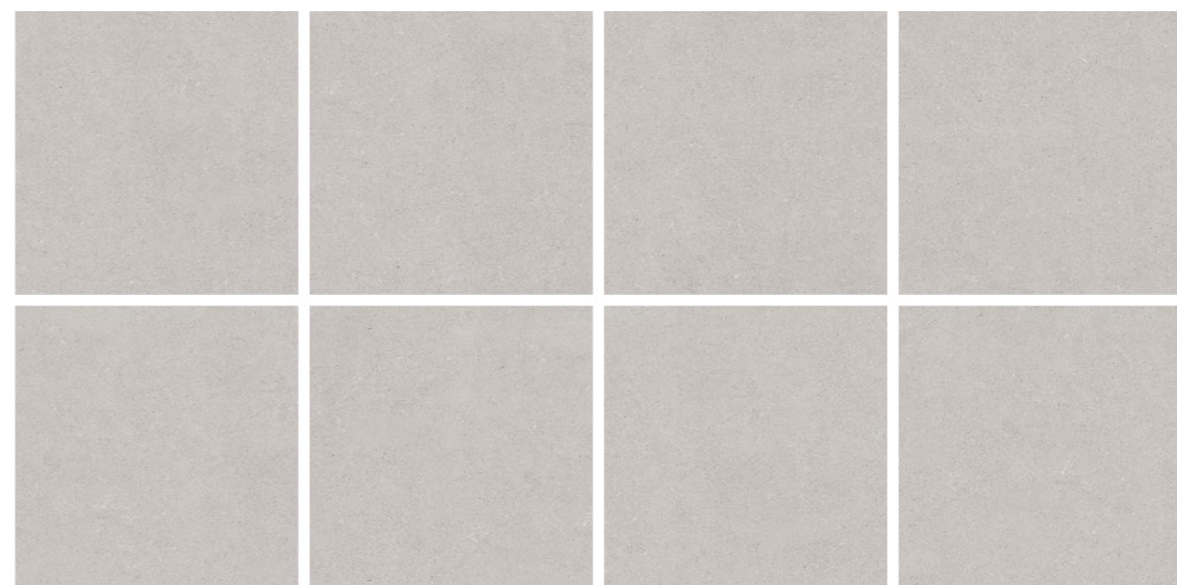



地：66742FA

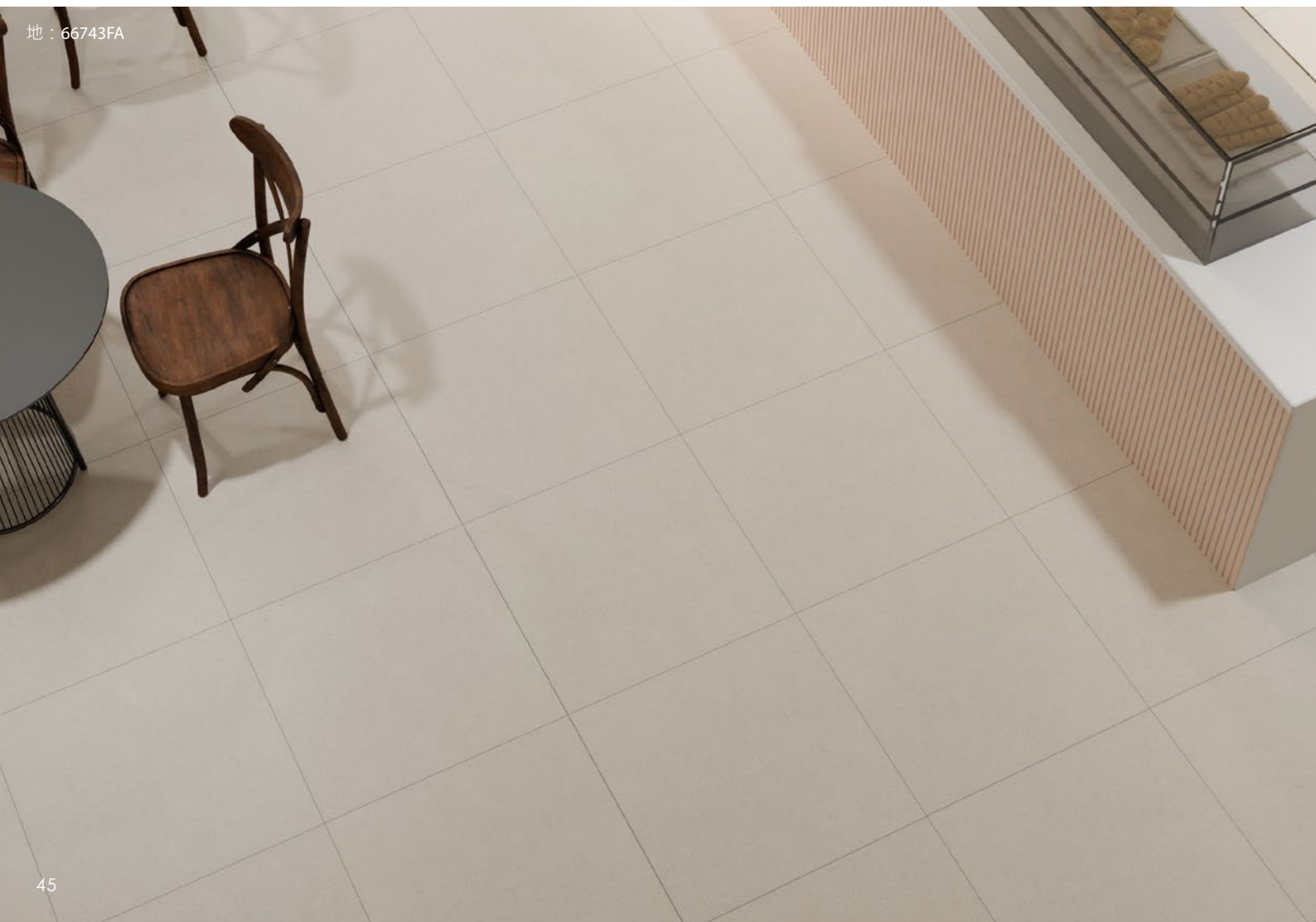

地：66743FA



地：66744FA

105x18.5 cm 模花/不修邊

V3

紋理變化
豐富



網頁介紹

10972R

經典原木

19種紋路



90x15 cm 模花/不修邊

V3

紋理變化
豐富



網頁介紹

95974R

經典原木

25種紋路



地：10972R



90x15 cm 平面/數位雙塗層/不修邊

雙圖層

V3

紋理變化
豐富



網頁介紹

95992FD

當代原木

25種紋路



90x15 cm 模花/防滑/不修邊

C.S.R
≥0.55

防滑

V3

紋理變化
豐富



網頁介紹

95970RA

經典原木

25種紋路



95973RA

經典原木

25種紋路



90x15 cm 模花/防滑/不修邊

C.S.R
≥0.55

防滑

V3

紋理變化
豐富



網頁介紹

95978RA

經典原木

25種紋路



壁&地：95973RA

70x15 cm 模花/啞光/不修邊

V3

紋理變化
豐富



網頁介紹

75955RM

當代原木

31種紋路



70x15 cm 模花/不修邊

V3

紋理變化
豐富



網頁介紹

75972R

經典原木

31種紋路



地：75955RM

70x15 cm 模花/防滑/不修邊



70x15 cm 模花/防滑/不修邊



75961RA 經典原木

31種紋路



75964RA 經典原木

31種紋路



75962RA 經典原木

31種紋路



75967RA 經典原木

31種紋路

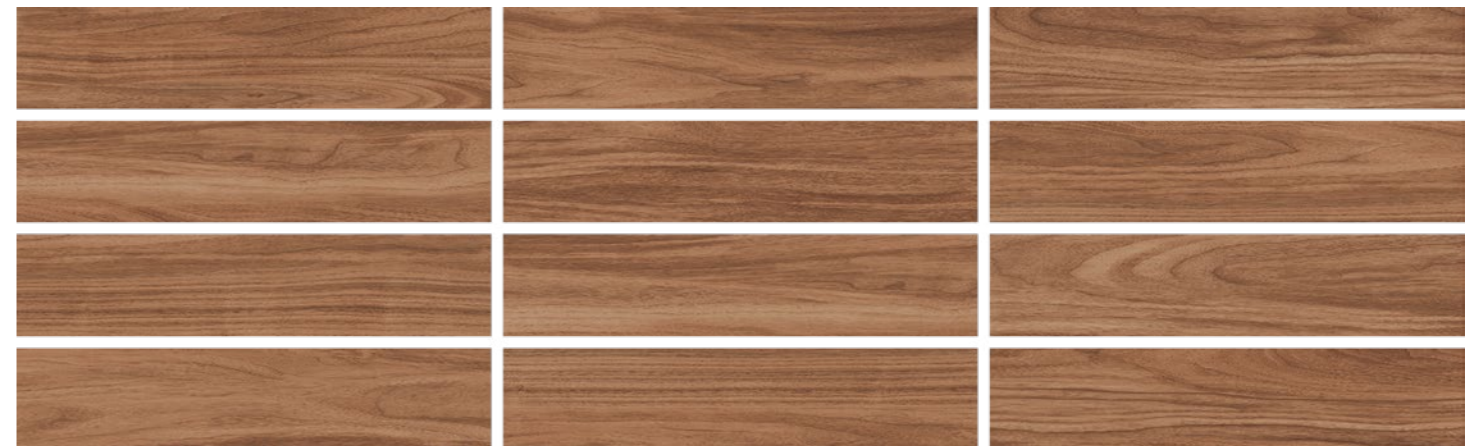



網頁介紹



網頁介紹

45960RA

經典原木

33種紋路



45962RA

經典原木

48種紋路



45961RA

經典原木

48種紋路



45963RA

經典原木

33種紋路





45964RA

經典原木

33種紋路



45967RA

經典原木

48種紋路



壁：45960RA



地：75961RA



地：95974R



壁&地：75962RA



45937R

新文化石

7種紋路

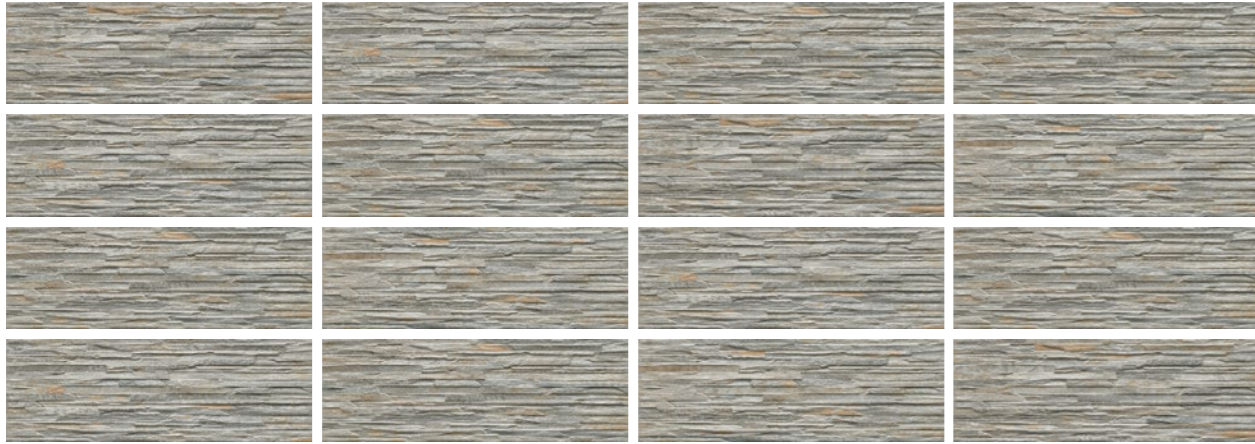

45939R

新文化石

7種紋路

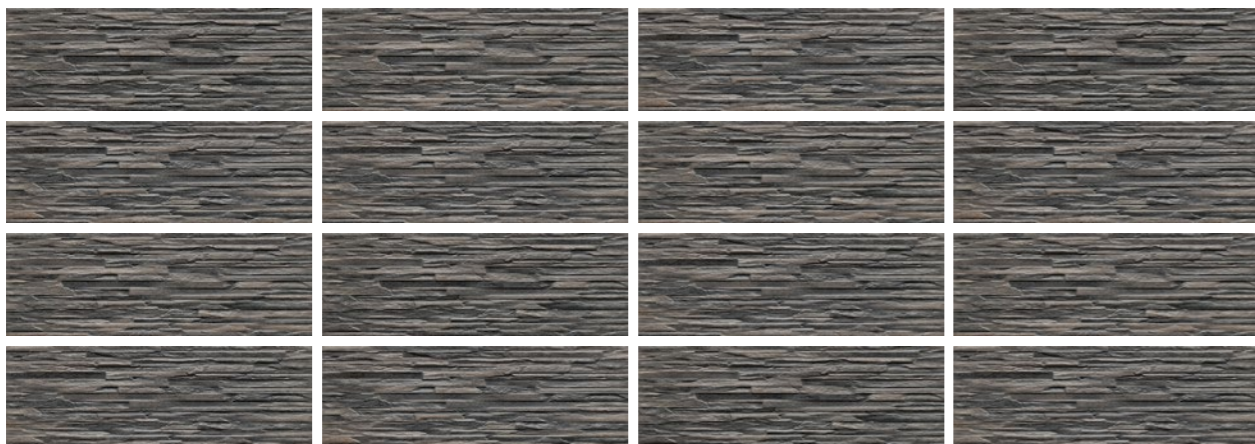

壁：45937R

90x30 cm 模花/修邊

V2

紋理變化
柔和



網頁介紹

39725R

雲峰

13種紋路



90x30 cm 平面/精雕雙塗層/修邊

V2

精雕雙塗層
紋理變化
柔和



網頁介紹

39760FE

雅緻石紋

13種紋路



90x30 cm 平面/修邊

V2

紋理變化
柔和



網頁介紹

39739F

雲峰

13種紋路



壁：39760FE



網頁介紹



網頁介紹

36190RA 厚片石板磚2.0

客訂
20種紋路



36191RA 厚片石板磚2.0

20種紋路

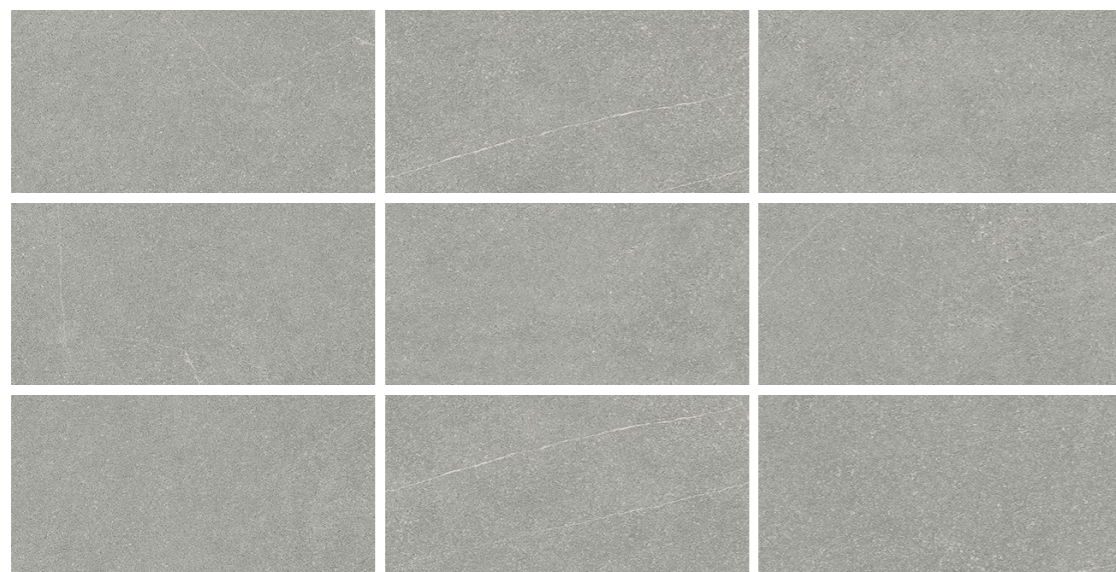

36192RA 厚片石板磚2.0

20種紋路



★36193RA 厚片石板磚2.0

20種紋路

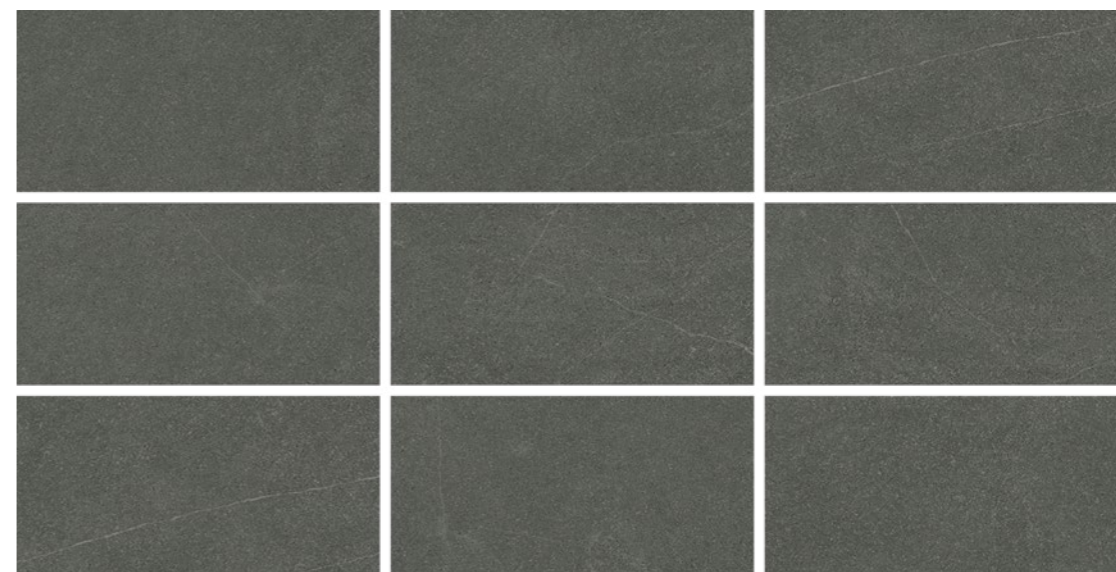

★為特別色等級

60x30 cm 模花/防滑/2cm厚磚/修邊



網頁介紹

60x30 cm 模花/防滑/2cm厚磚/修邊



網頁介紹

★36194RA 厚片石板磚2.0

客訂
20種紋路



客訂品基本訂貨量:1000m²，具體訂購需求歡迎洽詢

★36196RA 厚片石板磚2.0

20種紋路

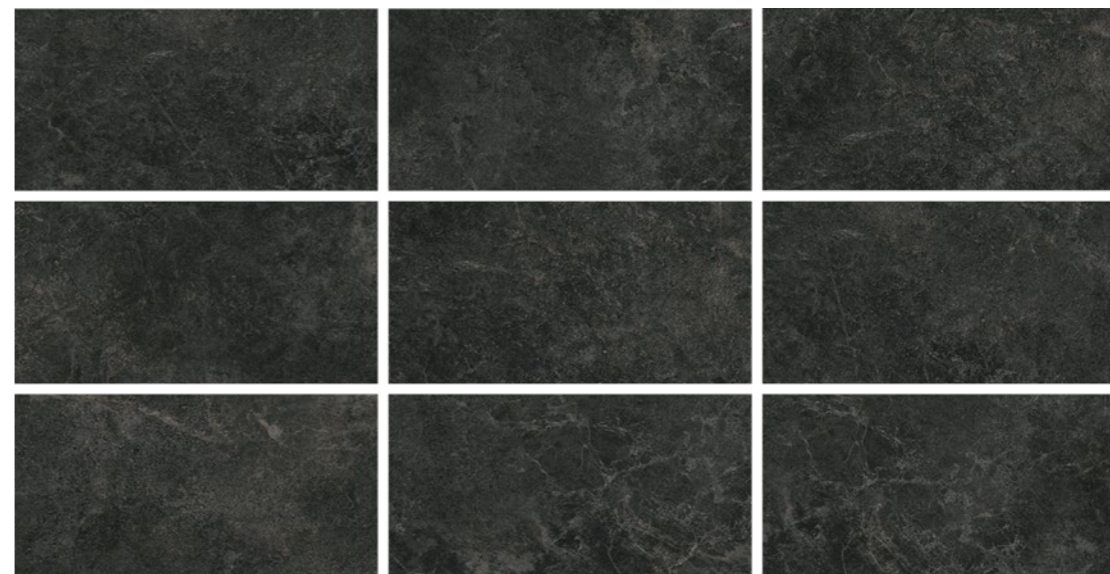

★36195RA 厚片石板磚2.0

20種紋路

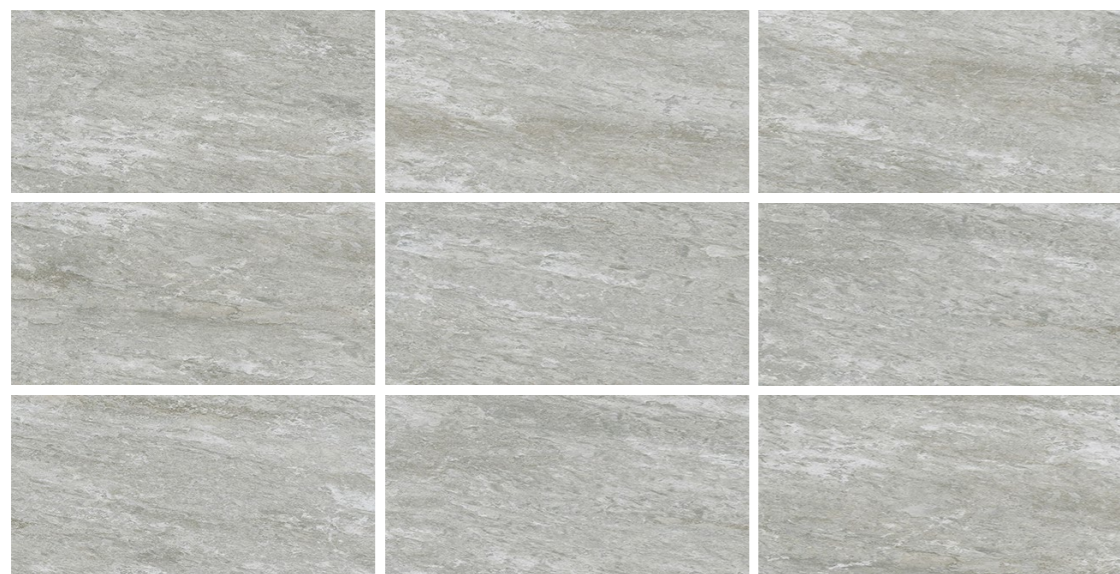

★為特別色等級

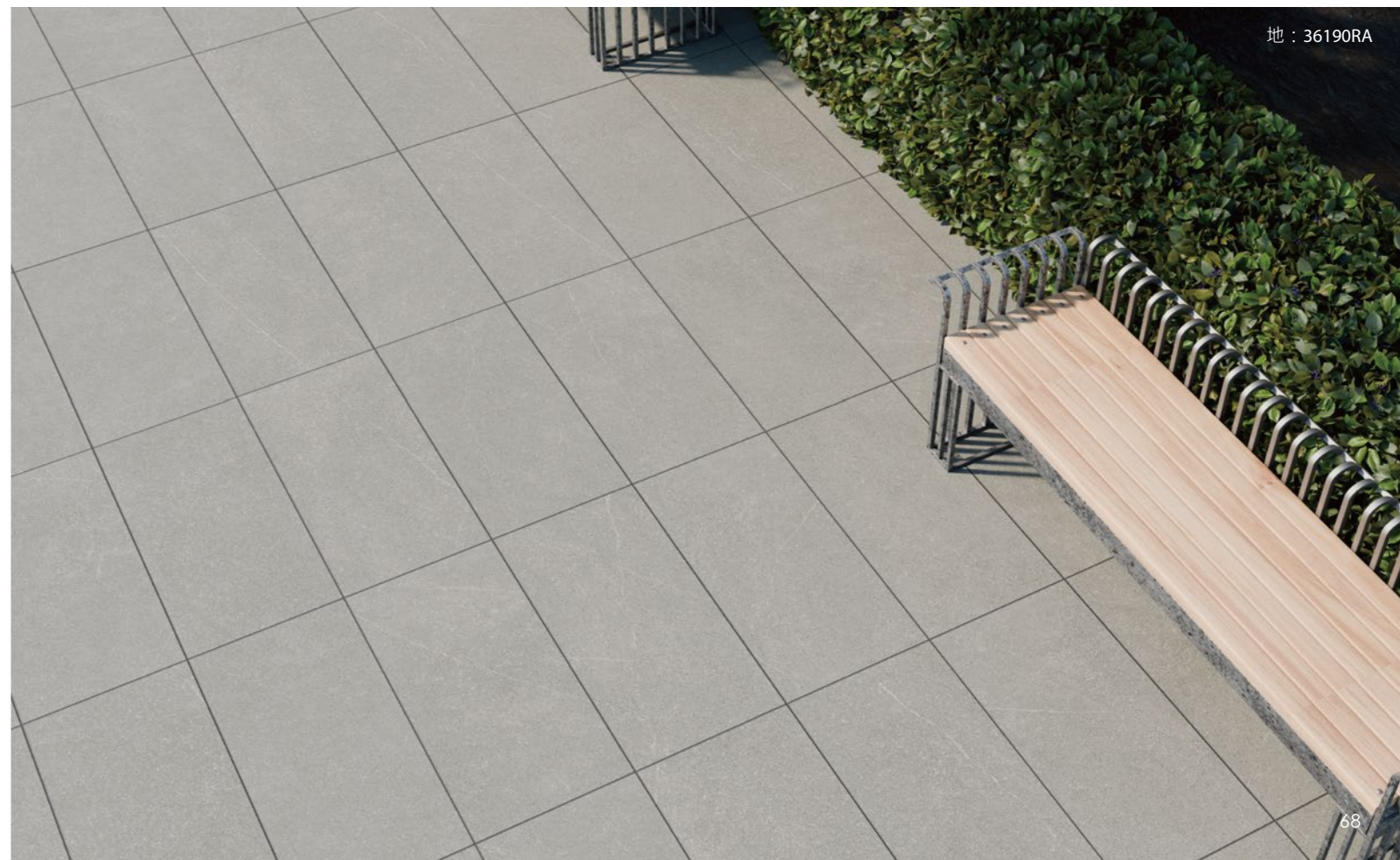

60x30 cm 模花/防滑/2cm厚磚/修邊



防滑



超厚實



紋理變化
柔和



網頁介紹

60x30 cm 模花/防滑/2cm厚磚/修邊



防滑



超厚實



紋理變化
柔和



網頁介紹

36102RA

原木厚磚

20種紋路



36198RA

原木厚磚

20種紋路



★36197RA

原木厚磚

20種紋路

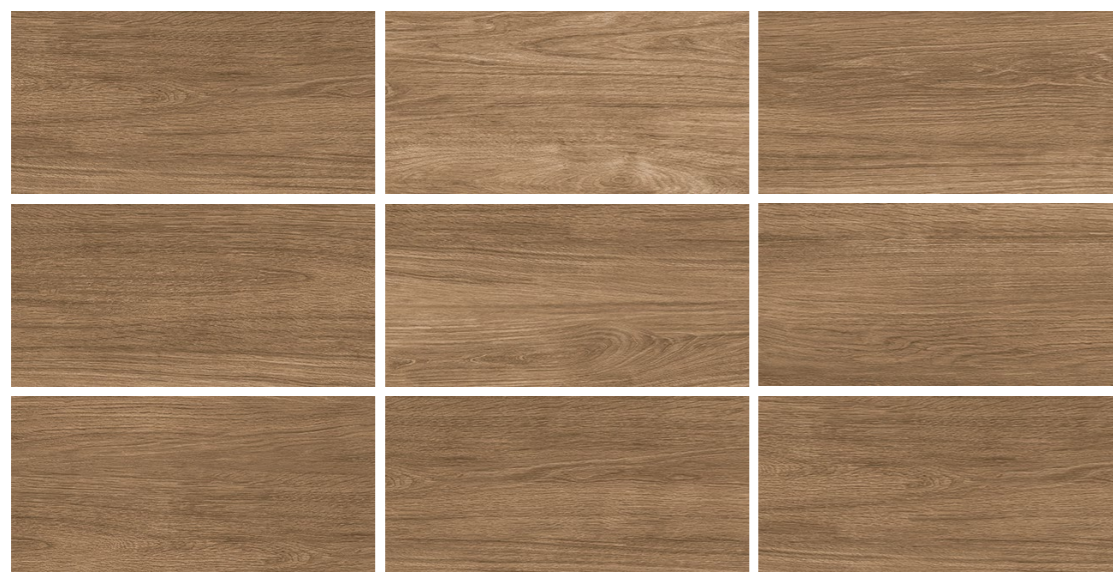

36199RA

原木厚磚

20種紋路



★為特別色等級

60x30 cm 模花/防滑/2cm厚磚/修邊

C.S.R
≥0.75
防滑

20mm
超厚實

V2
紋理變化
柔和



網頁介紹

36100RA

原木厚磚

20種紋路



★36109RA

原木厚磚

20種紋路



★為特別色等級



地：36109RA



網頁介紹



網頁介紹

36700FDA

雅境

20種紋路



36702FDA

雅境

20種紋路



36701FDA

雅境

20種紋路



36705FDA

雅境

20種紋路



60x30 cm 平面/數位雙塗層/防滑/修邊



網頁介紹

★36706FDA

雅境

20種紋路



★36709FDA

雅境

20種紋路

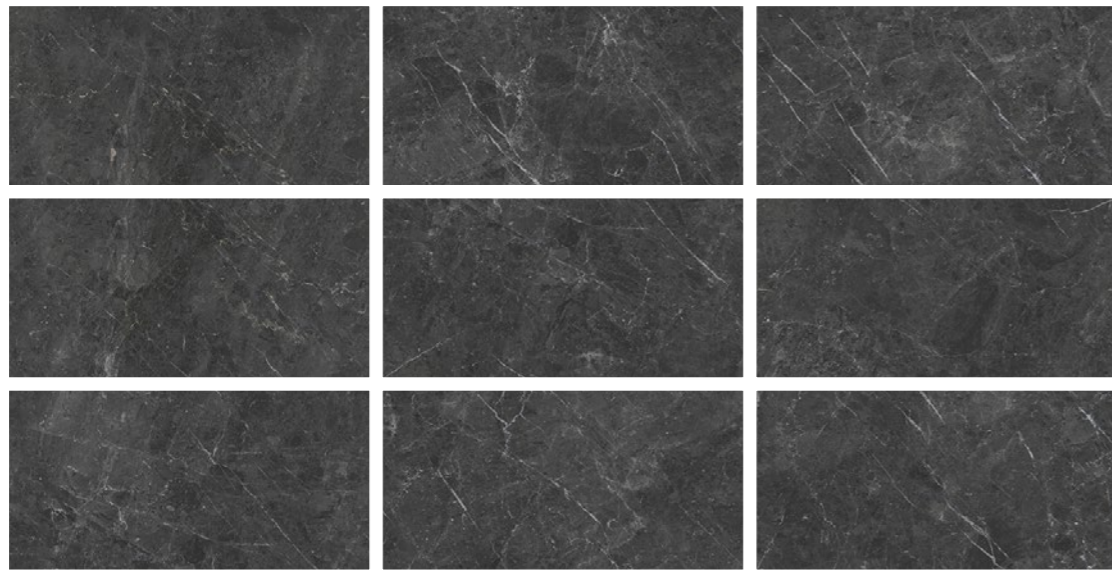

地：36709FDA





36740FA

澄石

18種紋路

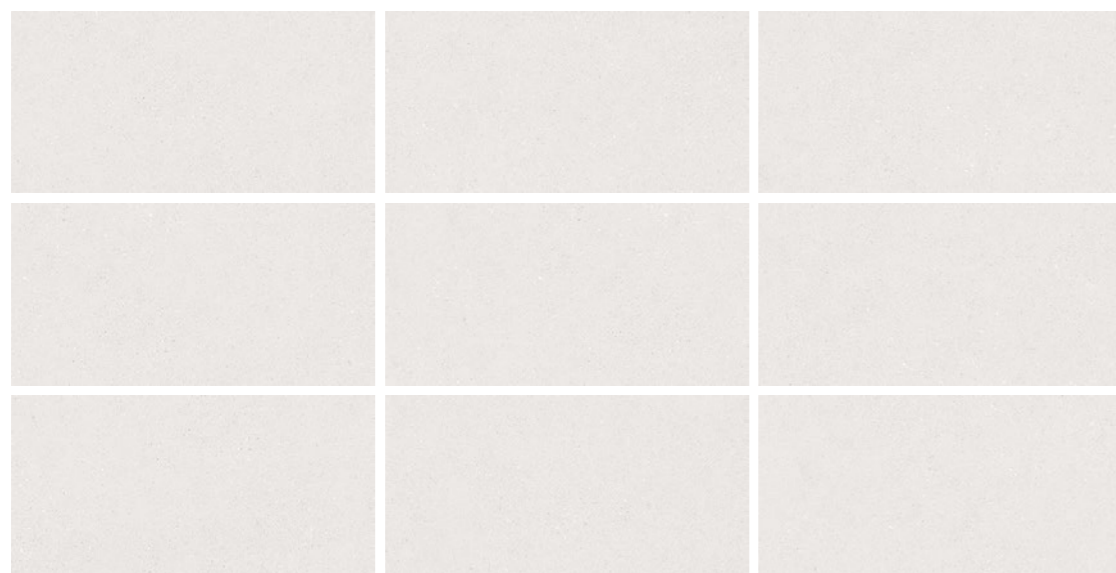

36742FA

澄石

18種紋路

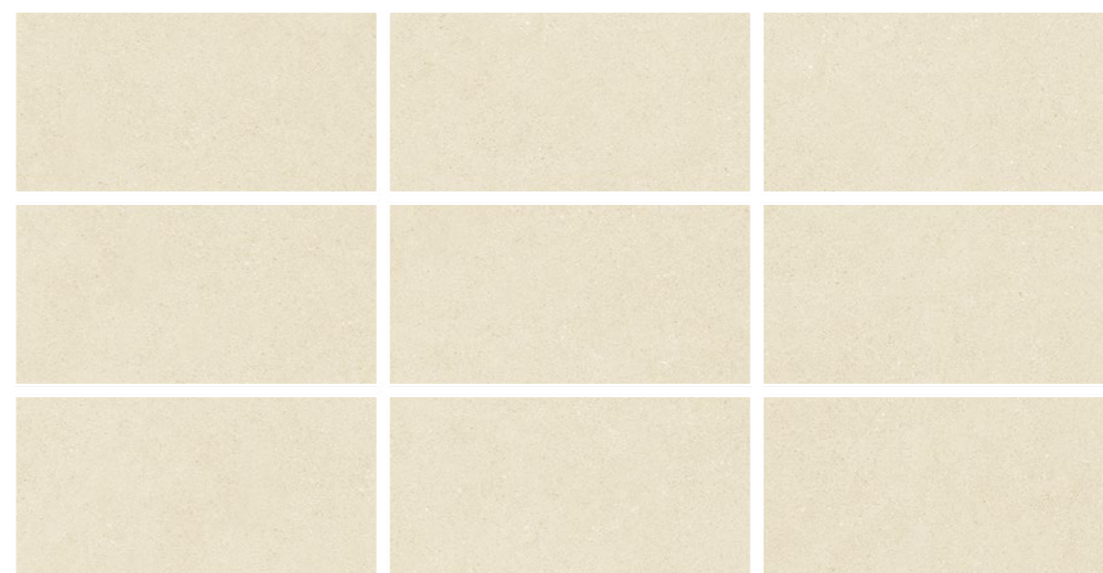

★36741FA

澄石

18種紋路

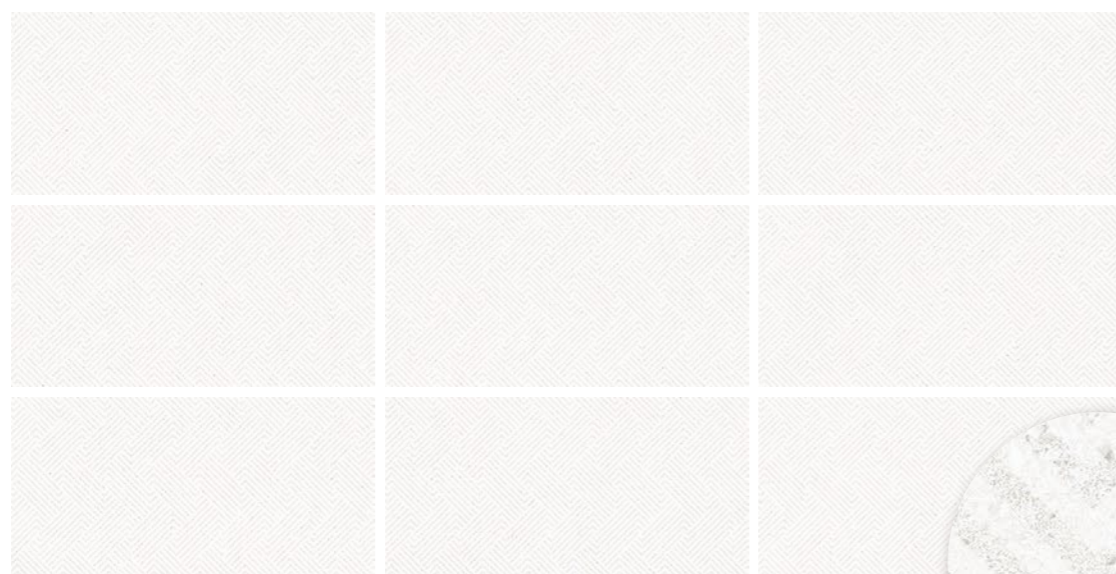

細部圖

36743FA

澄石

18種紋路

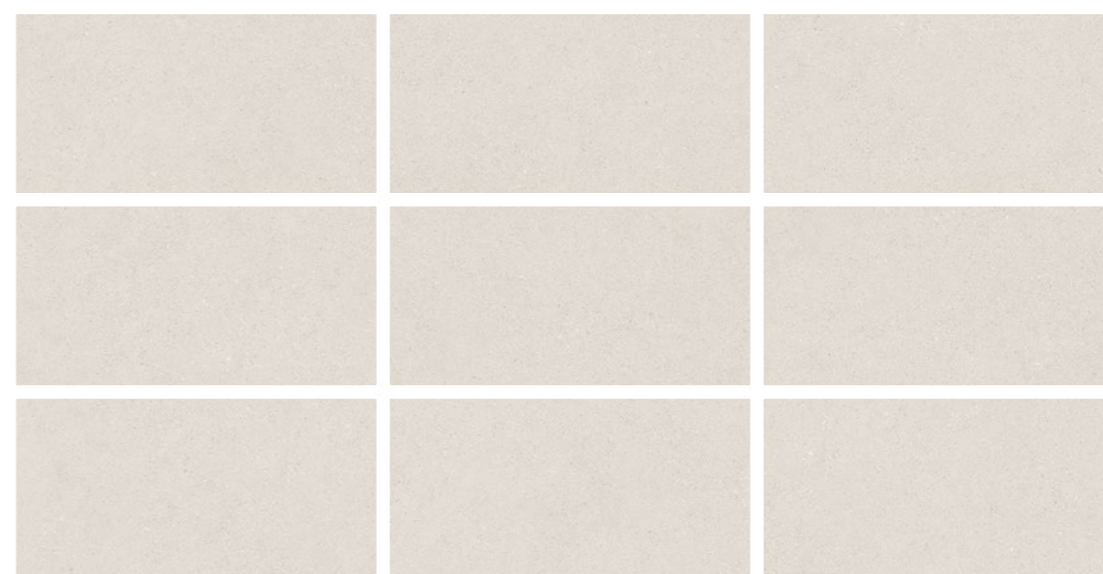

60x30 cm 平面/防滑

C.S.R
≥0.55
防滑

V2
紋理變化
柔和



網頁介紹

36744FA

澄石

18種紋路

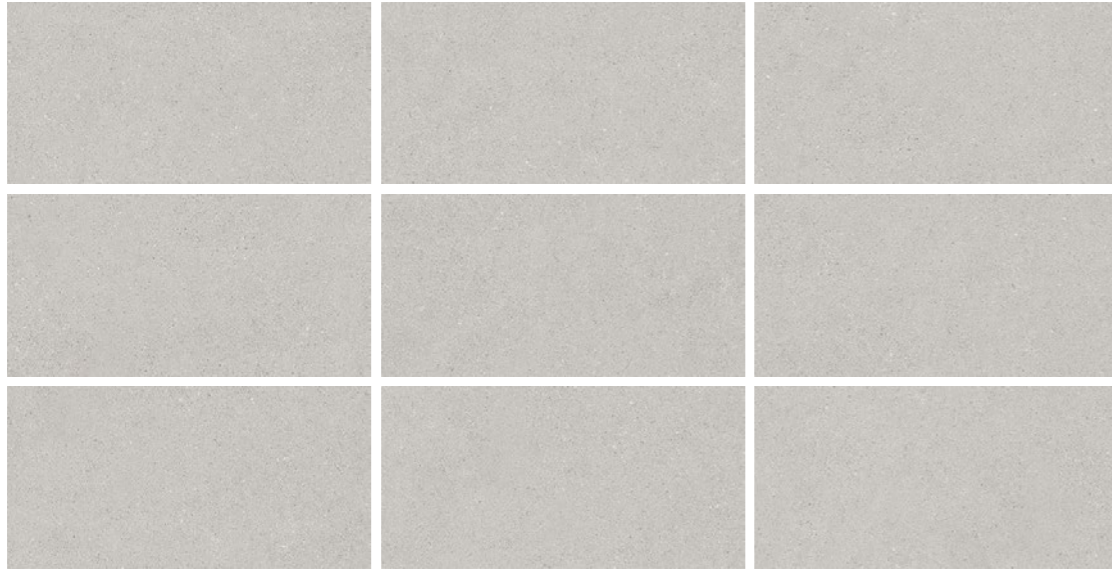

壁：36742FA、36744FA
地：30744FA

★36745FA

澄石

18種紋路

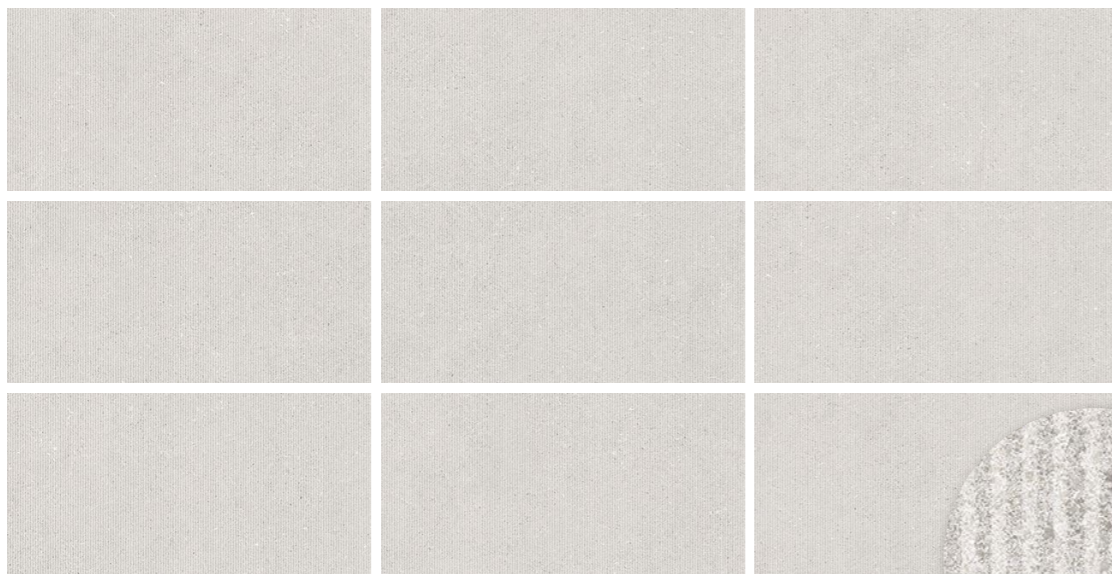

細部圖



地：36743FA



36130RA

龍岩2.0

19種紋路

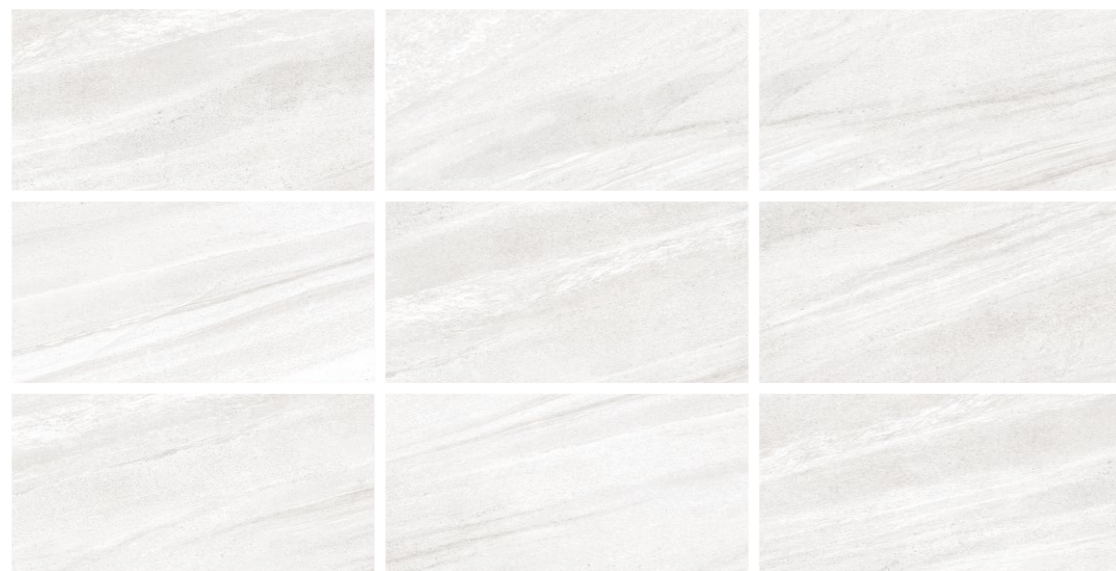

36131RA

龍岩2.0

19種紋路



36135RA

龍岩2.0

19種紋路

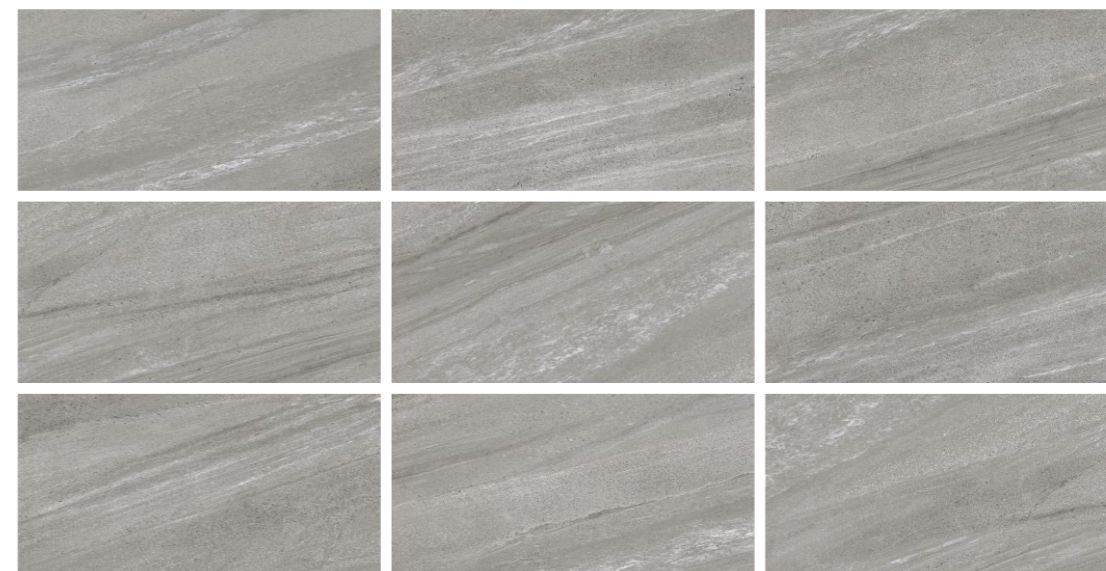

36139RA

龍岩2.0

19種紋路

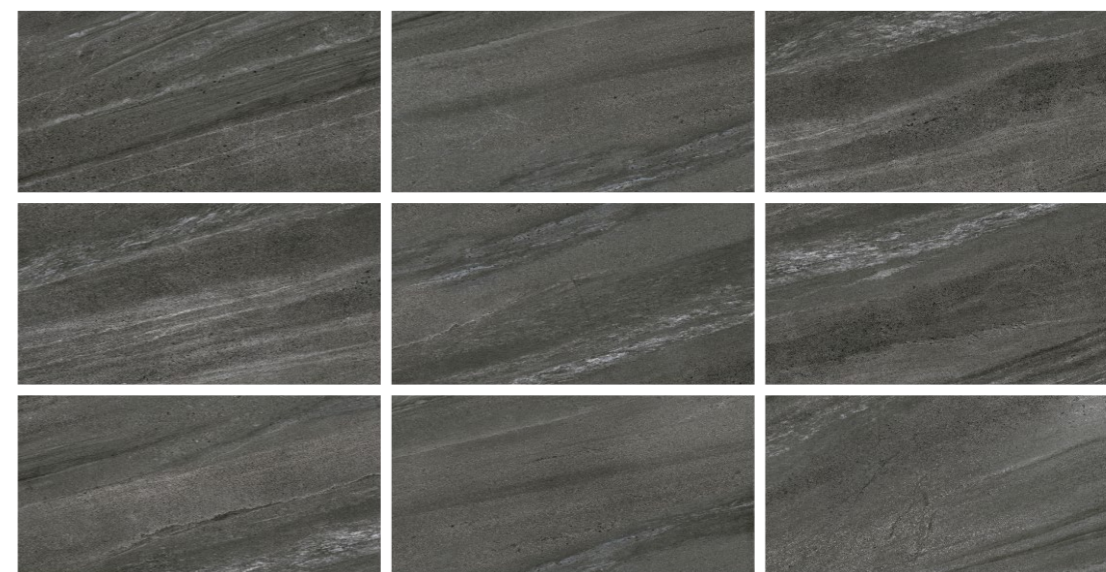



36114RA

板岩石四代

19種紋路



36117RA

板岩石四代

19種紋路



36115RA

板岩石四代

19種紋路



36119RA

板岩石四代

19種紋路

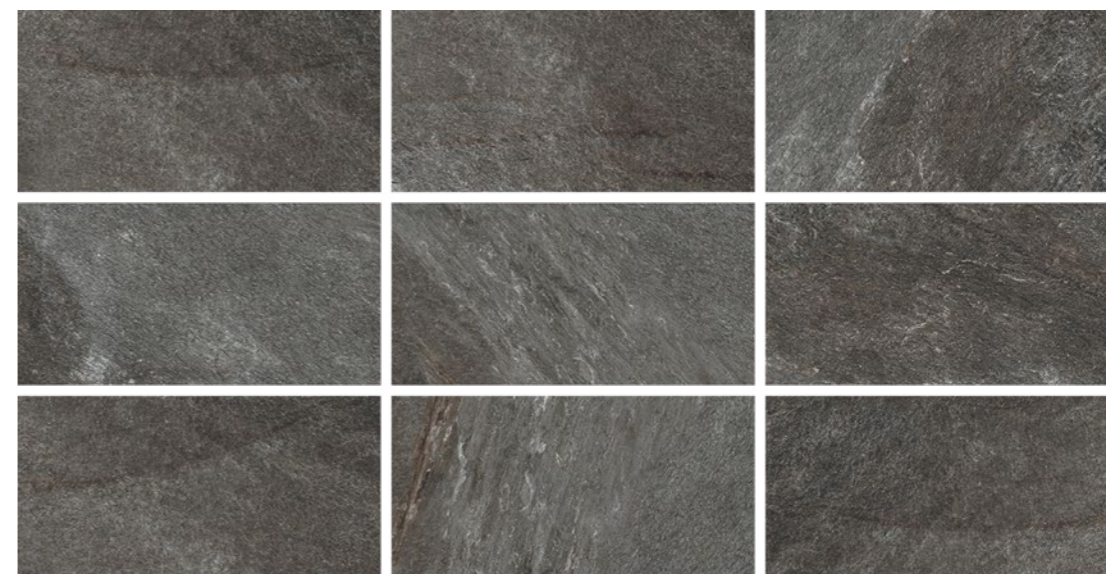



36121RA

原石

18種紋路



36129RA

原石

18種紋路



36125RA

原石

18種紋路

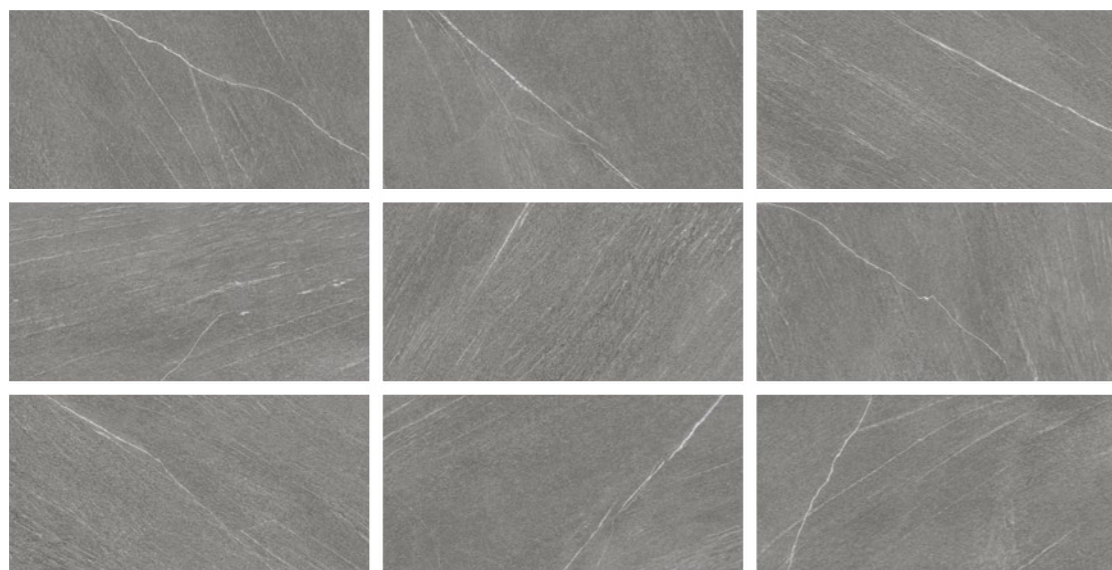

壁：36121RA、36129RA



36155RA

龍岩

20種紋路

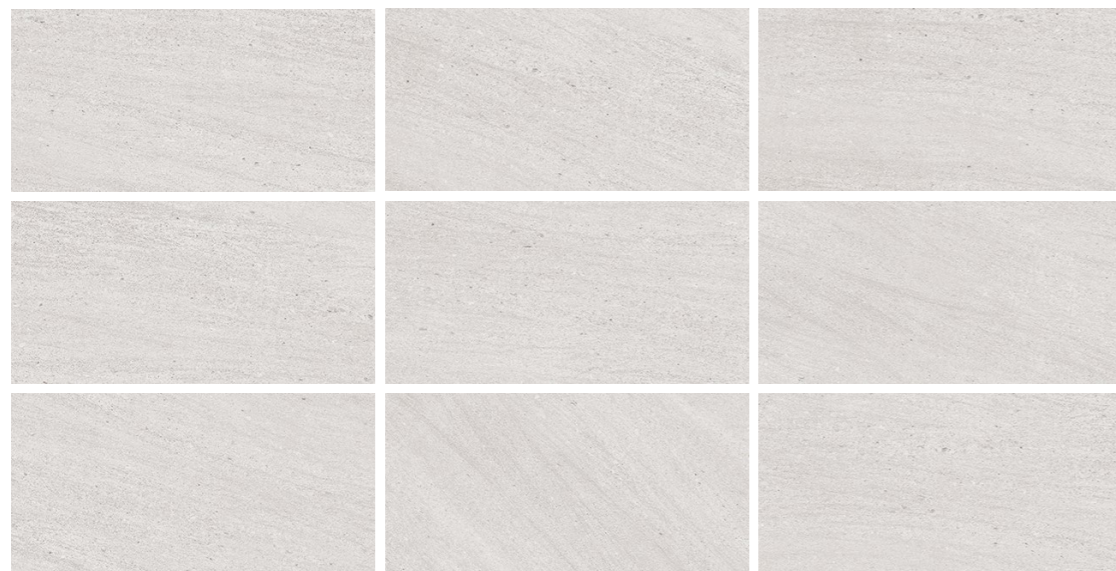

36156RA

龍岩

20種紋路

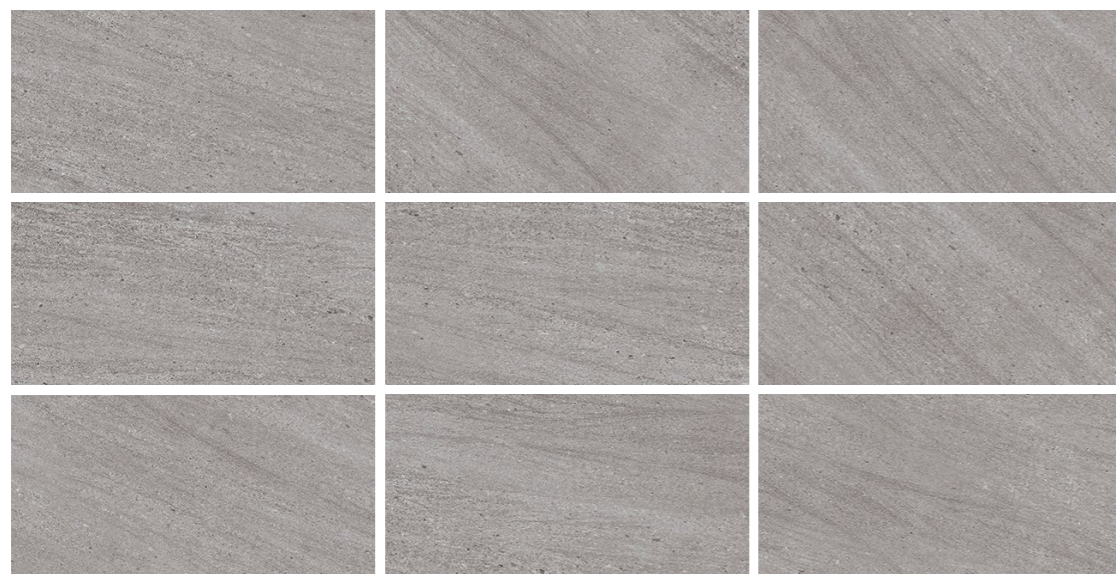

壁：36155RA
地：30155RA



地：36135RA



地：36119A



壁：36114RA、36117RA
地：32900R、32910R

60x30 cm 平面/釉拋/修邊



釉拋

V2

紋理變化
柔和



網頁介紹

36170FP

衛浴套磚-星澄

客訂
19種紋路

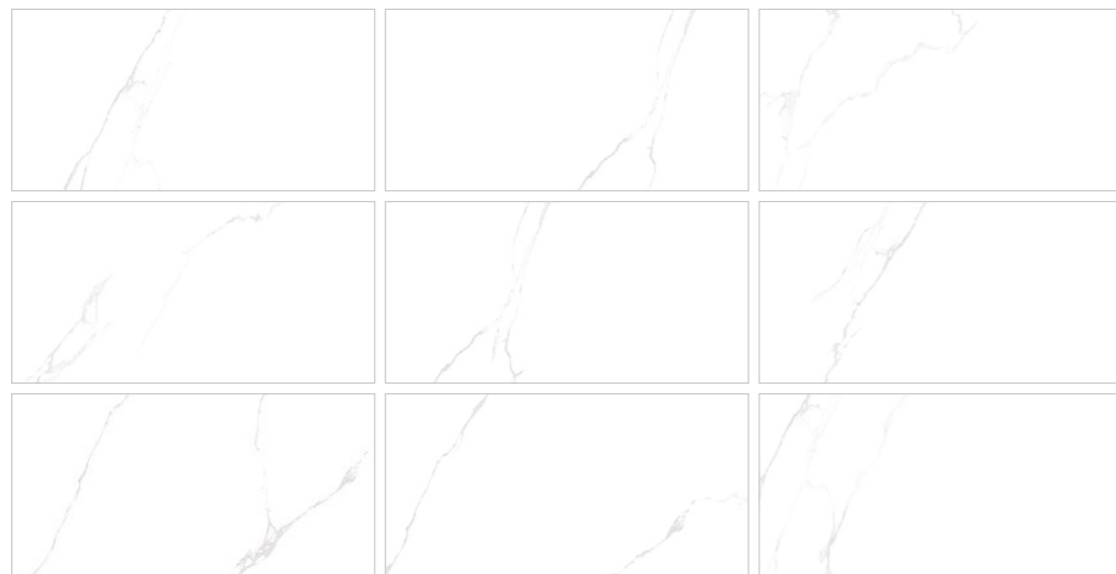

客訂品基本訂貨量:1000m²，具體訂購需求歡迎洽詢

36171FP

衛浴套磚-星澄

19種紋路



60x30 cm 平面/釉拋/修邊



釉拋

V2

紋理變化
柔和



網頁介紹

36172FP

衛浴套磚-星澄

客訂
19種紋路



客訂品基本訂貨量:1000m²，具體訂購需求歡迎洽詢

36173FP

衛浴套磚-星澄

19種紋路





釉拋



V2
紋理變化
柔和



網頁介紹

36174FP

衛浴套磚-星澄

19種紋路

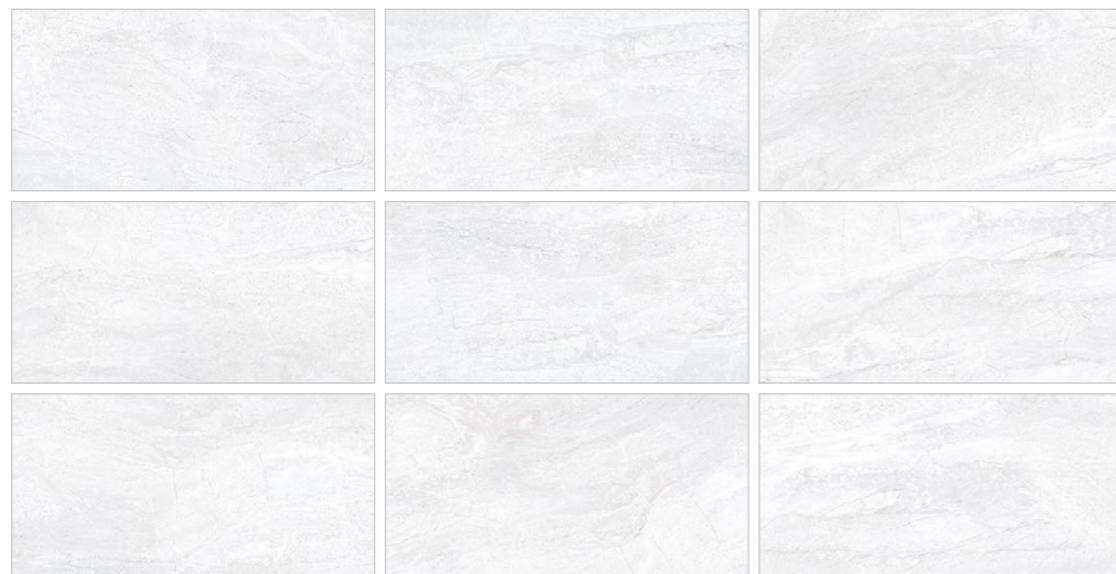

36175FP

衛浴套磚-星澄

19種紋路

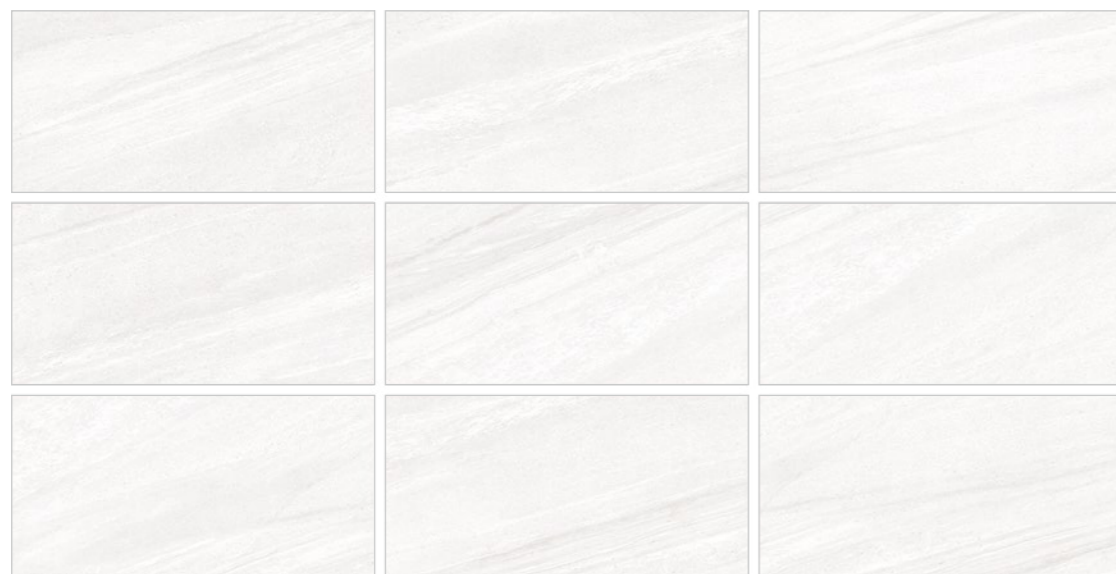

壁：36102FD、36174FP
地：36155RA



壁：36170FP



壁：36173FP



壁：36171FP
地：36130RA



36140F

衛浴套磚-水韻

19種紋路

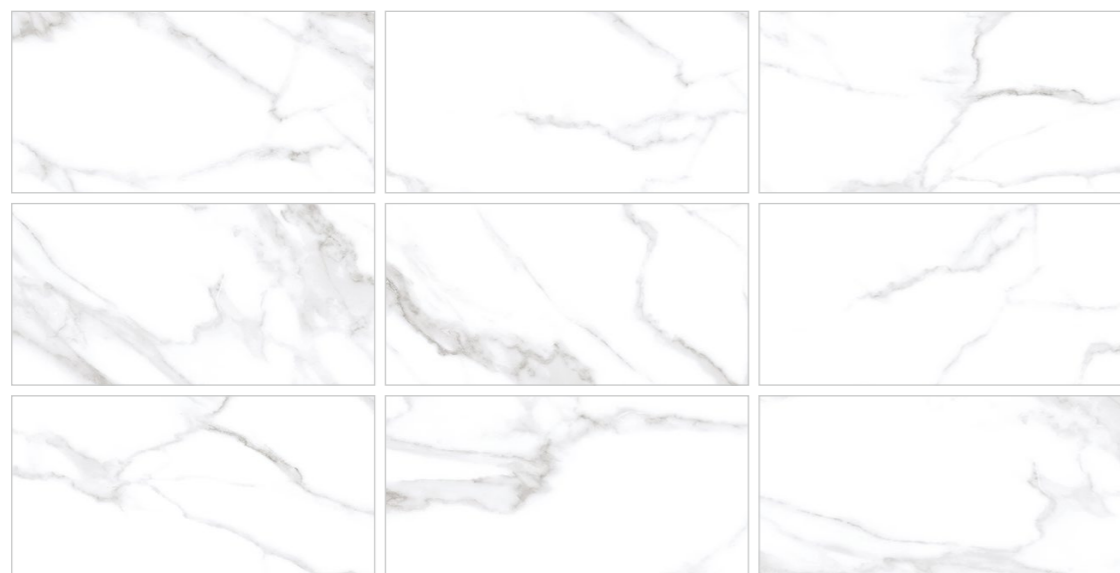

36141F

衛浴套磚-水韻

19種紋路



36142F

衛浴套磚-水韻

19種紋路

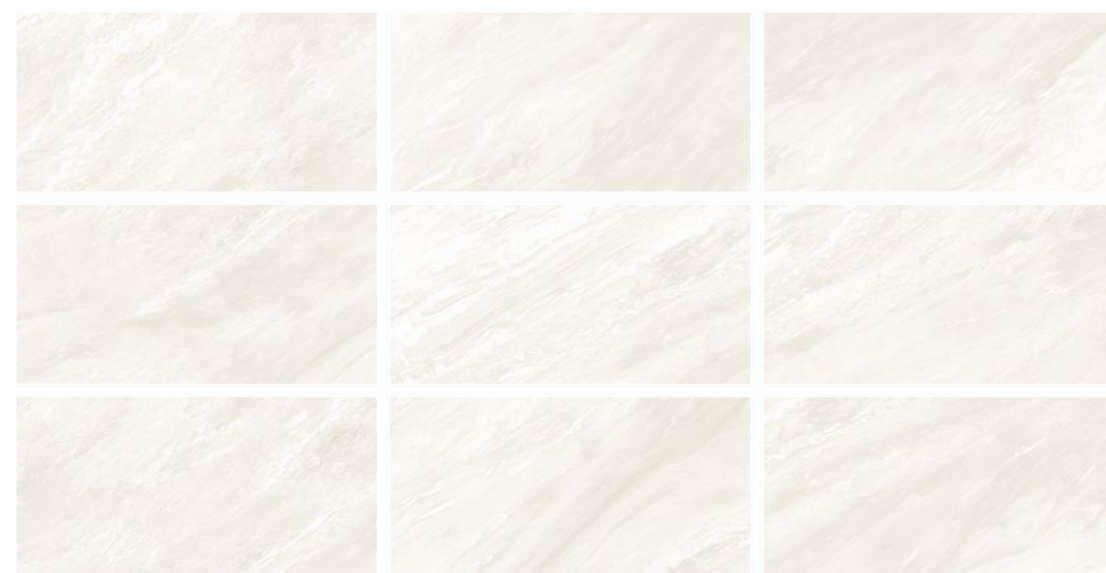

壁：36140F
地：30340RA

60x30 cm 平面/啞光/修邊

V2

紋理變化
柔和



網頁介紹

36145FM

衛浴套磚-水韻

19種紋路

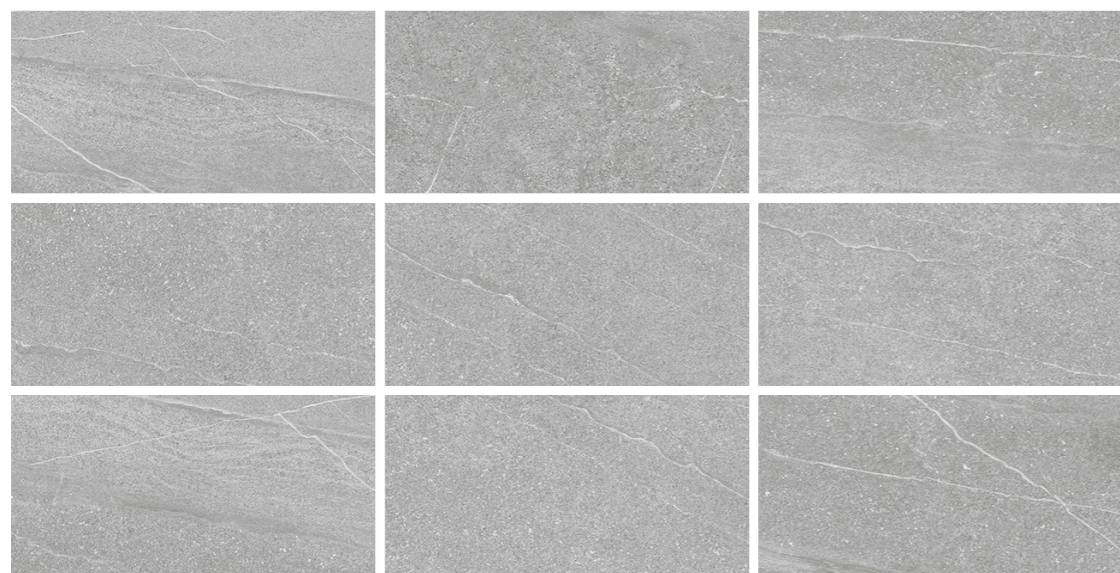

36146FM

衛浴套磚-水韻

19種紋路

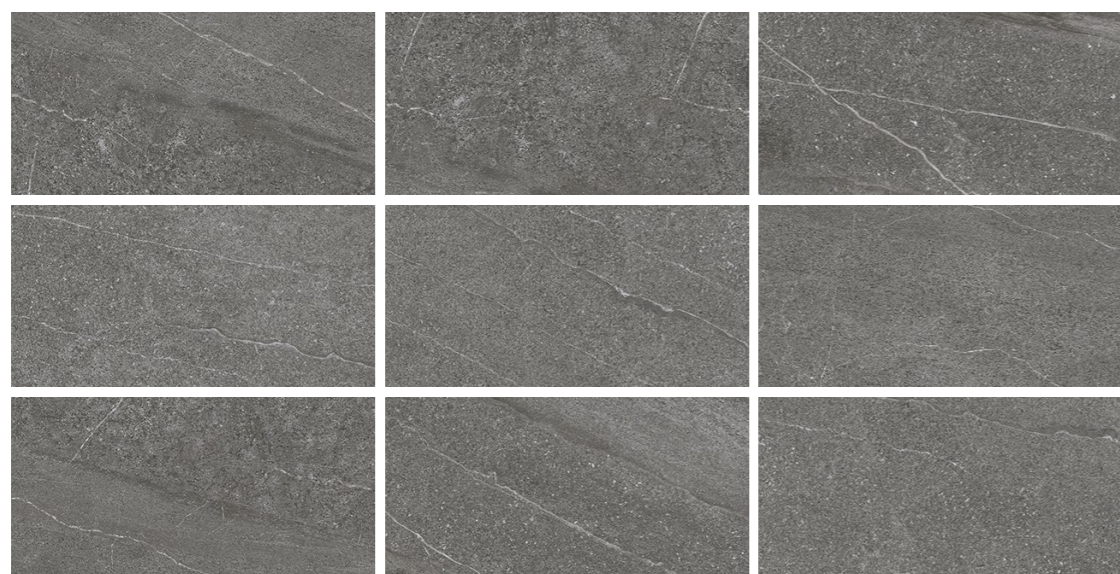

60x30 cm 平面/啞光/修邊

V2

紋理變化
柔和



網頁介紹

36147FM

衛浴套磚-水韻

19種紋路



60x30 cm 平面/防滑/修邊

C.S.R
≥0.55

防滑

V2

紋理變化
柔和



網頁介紹

36144FA

衛浴套磚-水韻

19種紋路

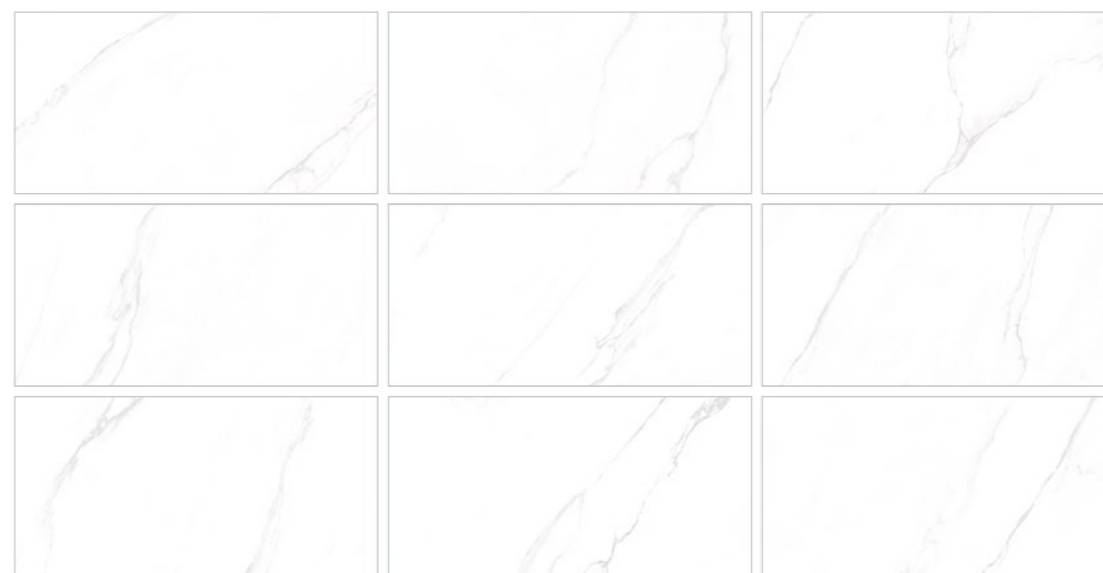



壁：36144FA、36108FA
地：30144RA

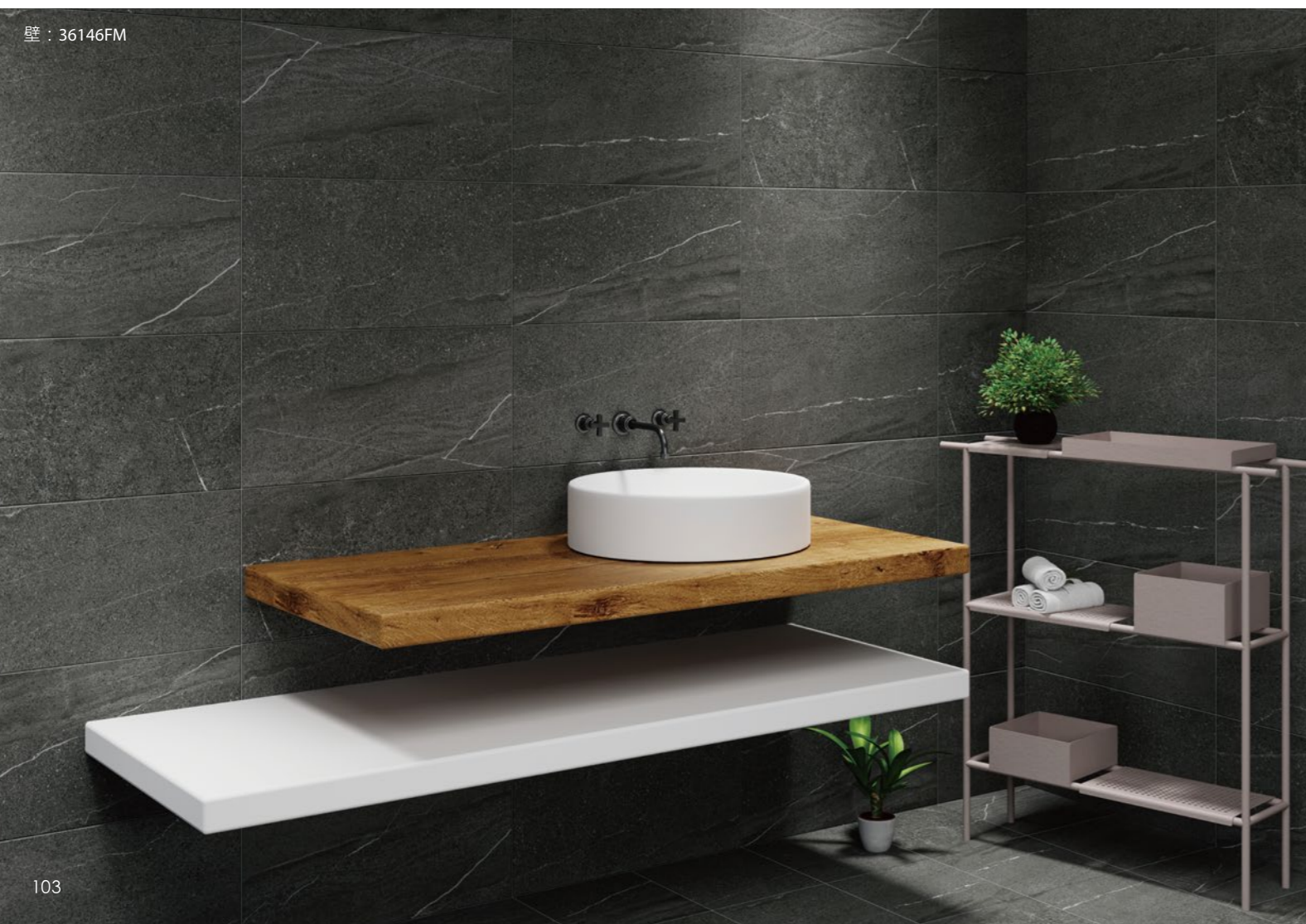

壁：36146FM



壁：36106F、36142FA
地：30342RA

30x30 cm 自然面/防滑/不修邊

C.S.R
≥0.55
防滑

V2
紋理變化
柔和



網頁介紹

30x30 cm 自然面/防滑/不修邊

C.S.R
≥0.55
防滑

V2
紋理變化
柔和



網頁介紹

30331RA 龍岩2.0三合一

38種紋路

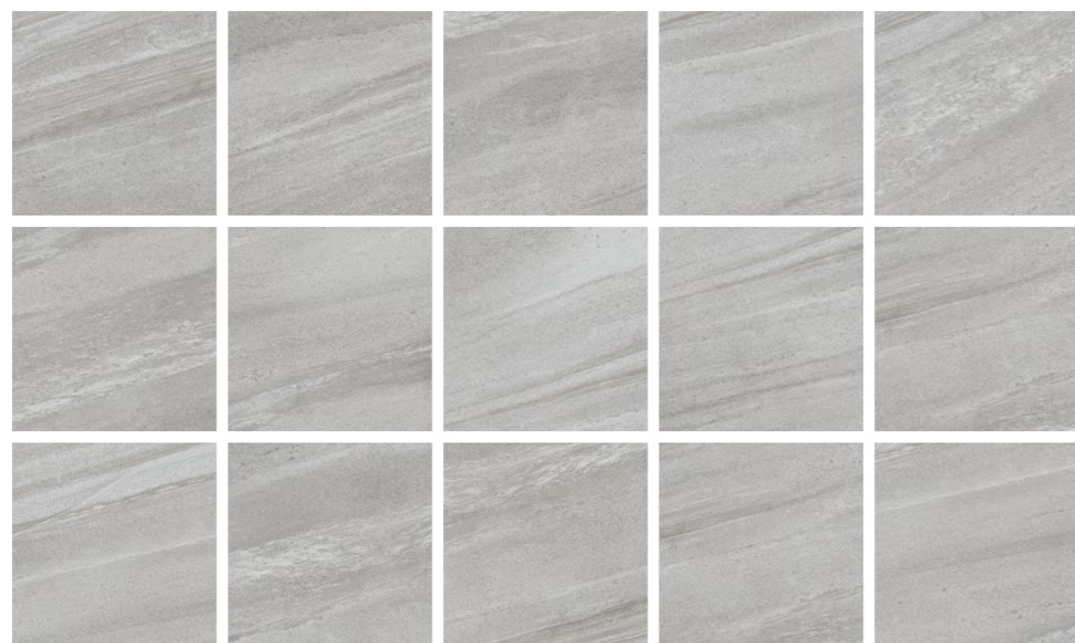

30339RA 龍岩2.0三合一

38種紋路

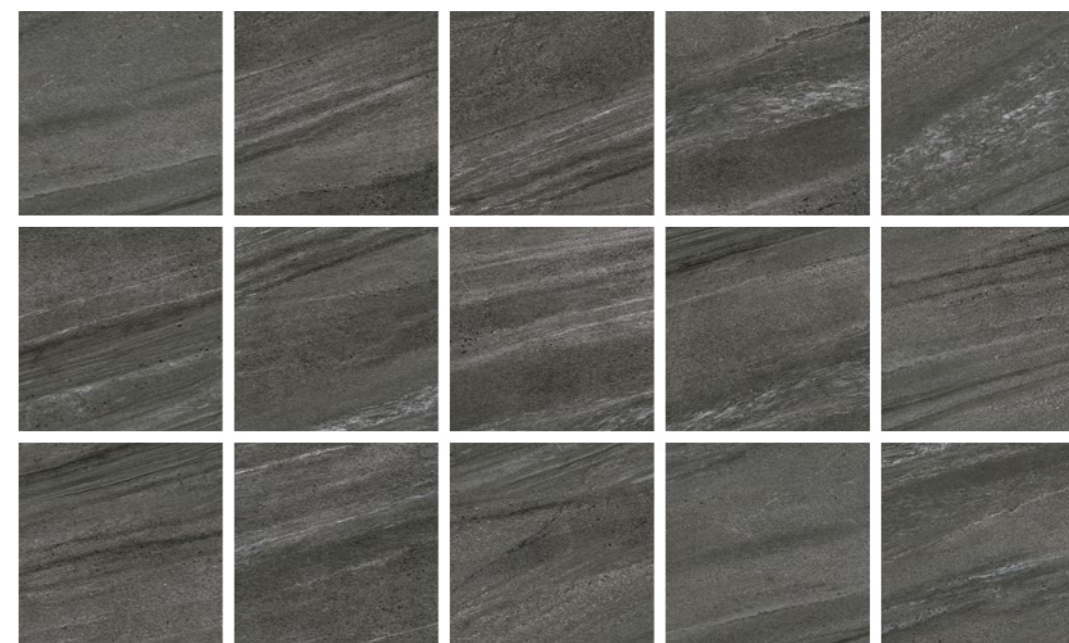

30335RA 龍岩2.0三合一

38種紋路



壁：36175FP
地：30335RA



30914RA 板岩石四代三合一

38種紋路



30917RA 板岩石四代三合一

38種紋路



30915RA 板岩石四代三合一

38種紋路



30919RA 板岩石四代三合一

38種紋路



30x30 cm 模花/防滑/不修邊



30x30 cm 模花/防滑/不修邊



30345RA 衛浴套磚-水韻

36種紋路



30347RA 衛浴套磚-水韻

36種紋路



30346RA 衛浴套磚-水韻

36種紋路

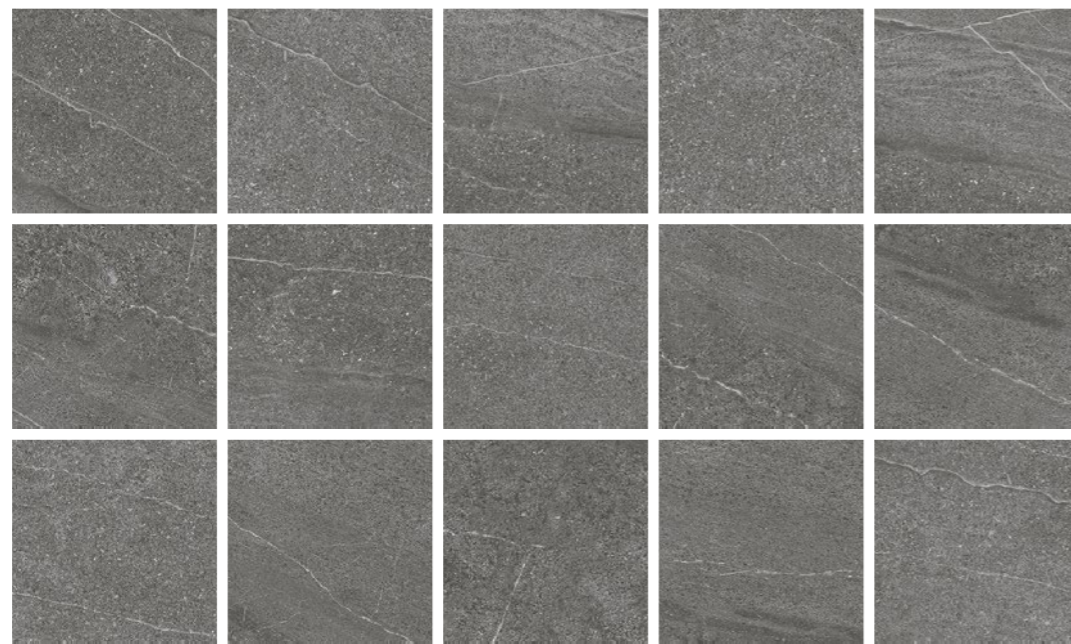

地 30345RA

30x30 cm 模花/防滑/不修邊



耐久設計



防滑



紋理變化豐富



網頁介紹

30925RA

原石三合一

38種紋路



地：30914RA



地：30925RA



地：30915RA

實績案例

高雄得邑建設-和野學

鋪貼產品：66195RA、66196RA、36195RA、36196RA



包裝明細

規格/mm	包裝數量 片/件	換算數量 片/m ²	施工用量 片/坪	規格/mm	包裝數量 片/件	換算數量 片/m ²	施工用量 片/坪
298x298x8.8 (不修邊)	15	11.1	36	799x799x10 (修邊)	2	1.6	5
450x147x9.3 (不修邊)	15	14.8	48	899x147x8 (不修邊)	11	7.4	24
450x147x9.5 (不修邊)	15	14.8	48	899x298x9.5 (修邊)	5	3.7	12
599x298x7 (修邊)	9	5.5	18	1050x185x9.3 (不修邊)	8	5.2	17
599x298x8 (修邊)	8	5.5	18	1050x480x10 (修邊·樓梯)	3	--	--
599x298x20 (修邊)	4	5.5	18	1200x480x10 (修邊·樓梯)	2	--	--
599x599x8 (修邊)	5	2.8	9	1200x599x10 (修邊)	2	1.4	4.5
599x599x20 (不修邊)	2	2.8	9	1200x599x20 (修邊)	1	1.4	4.5
695x145x8 (不修邊)	14	9.9	32				



-台灣在地生產製造-

數位科技-領先國內同業技術

影像逼真-400dpi高解析度畫素



ISO 9001
國際品質認證
4XBV054



昌達陶瓷股份有限公司
HILAND CERAMICS CO.,LTD.